

duravent™

DuraSeal®

Single-Wall, Double-Wall and Double-Wall
Insulated Special Gas Vent



AV

DuraSeal® DS, DSD, DSID, & Flex

QUALITY AND DEPENDABILITY

The DuraSeal flue is manufactured from stainless steel designed for extreme resistance to chloride ion pitting, crevice corrosion and stress corrosion cracking, as well as general corrosion in oxidizing and moderately reducing environments. 29-4C is the standard choice, but also available in 316L, for withstanding the harmful effects of corrosive condensates created by partially or fully condensing high-efficiency natural gas and propane-fired heating appliances.

The Canadian Gas Research Institute found that test results proved 29-4C and 316L to be one of the two “most corrosion-resistant alloys of 20 candidate stainless steels evaluated for resistance to chloride-induced corrosion in condensing and partially condensing gas-fired appliances.”

STRINGENT STANDARDS FOR QUALITY ASSURANCE

To guarantee a perfect fit every time and to avoid built-in stress points or weak areas, tube ends are formed under stringent guidelines and held to exacting standards.

The casing (outer tube on DuraSeal DSD/DSID) is manufactured from type 441 stainless steel to provide long-lasting performance and stability when exposed to the outdoors.

The air space between the flue and casing is 1” on DSD and 2” insulated on DSID, providing close clearances to combustibles, reasonable outside dimensions and an additional heat shield or margin of safety where needed.

BUILT TO LAST

DuraSeal features a smooth weld seam inside and out, which is completely shielded during the welding process. Contamination or molecular changes in the weld seam are avoided and no fillers are used in the welding process.

The DuraSeal double-wall system is fully interchangeable with our DuraSeal single-wall system. Both have been conformed to UL1738 and certified to ULC-S636 safety standards. When installed according to Duravent installation instructions, DuraSeal meets all test requirements for horizontal and vertical, interior or exterior installations. DSID features the same construction as DSD, but with 2” air space filled with mineral wool insulation.



DURAVENT DURASEAL SINGLE WALL AND DOUBLE WALL GAS VENT



Features	Benefits
Laser butt-welding	<ul style="list-style-type: none">• Reinforces strength• Prevents leakage• Increases durability and reliability
Built-in DuraLock system	<ul style="list-style-type: none">• Provides quick and easy assembly and disassembly• Requires less time on the job site
DuraSeal sealing gaskets	<ul style="list-style-type: none">• Self-sealing, so there's no need to apply sealing material when pieces are joined together• Easier and faster installation
Standard adjustable vent length	<ul style="list-style-type: none">• Provides vertical or horizontal adjustment for easy system pitching
29-4C stainless steel standard or 316L stainless steel alternative	<ul style="list-style-type: none">• Resists the extreme corrosive environments found in condensing boilers• Assures safe and trouble-free operation
Proven track record	<ul style="list-style-type: none">• Conformed to UL1738 and certified to ULC-S636• Type L: Listed to UL-641 and ULC-S609 (DSD/DSID)• 15-year warranty
All accessories made of stainless steel	<ul style="list-style-type: none">• For durability

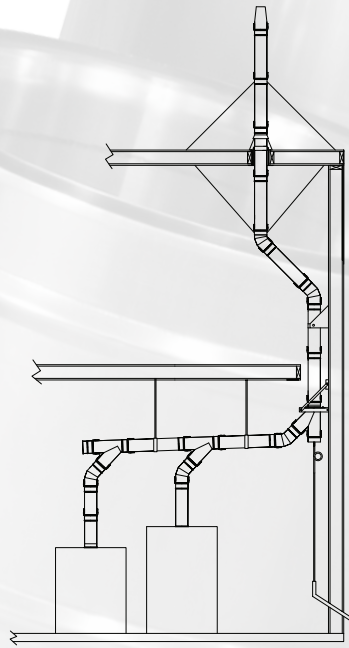

DuraSeal Single Wall (DS)
Vertical Installation



DuraSeal Double Wall (DSD) Vertical
Through-the-Roof Installation

Effective Length:
When assembling two parts together, the joint will overlap 2-3/8". So effective length is normal length minus 2-3/8".

Vertical Installation Requirements

1. The vent system must terminate at least 3 feet above the roof line and at least 2 feet higher than any portion of the building within 10 feet. This limitation can be removed if an engineering analysis demonstrates normal and safe operation of appliance.

2. When terminated at a height of more than 10 feet, the stack must be supported by a Guy Section.

3. The vent system must terminate with one of the DuraSeal terminations.

DURASEAL SINGLE WALL (DS)

Minimum Clearance to Combustibles

Diameter	Rated operating temperature	Max flue gas temperature	Enclosed		Unenclosed	
			Horizontal	Vertical	Horizontal	Vertical
3" to 12"	194° F/90° C (Canada Only)	550° F	N/A	N/A	0"	0"
	480° F	550° F	N/A	N/A	2"	2"
14" to 24"	194° F/90° C (Canada Only)	550° F	N/A	N/A	0"	0"
	480° F	550° F	N/A	N/A	4"	4"

DURASEAL DOUBLE WALL (DSD/DSID)

Minimum Clearance to Combustibles

Diameter	Rated operating temperature	Max flue gas temperature	Enclosed		Unenclosed	
			Horizontal	Vertical	Horizontal	Vertical
3" to 12"	194° F/90° C (Canada Only)	550° F	N/A	0"	0"	0"
	480° F	550° F	N/A	1"	1"	1"
14" to 24"	194° F/90° C (Canada Only)	550° F	N/A	0"	0"	0"
	480° F	550° F	N/A	1"	3"	1"
3" to 12" (L-Vent)	194° F/90° C (Canada Only)	570° F	N/A	0"	0"	0"
	480° F	570° F	N/A	2"	2"	2"
14" to 24" (L-Vent)	194° F/90° C (Canada Only)	570° F	N/A	0"	0"	0"
	480° F	570° F	N/A	2"	3"	2"

Material Thickness

Diameter	Inner Wall Material Thickness	Outer Wall Material Thickness
3" - 9"	29-4C - .015" 316L - .015"	29-4C - .015" 316L - .015"
10" - 16"	29-4C - .020" 316L - .019"	29-4C - .020" 316L - .019"
18" - 24"	29-4C - .024" 316L - .024"	29-4C - .024" 316L - .024"

PART NUMBERS

These instructions identify major model DS-DSD-DSID parts by name and part number.

Material Code Designations	
B	Type 316 Stainless Steel
H	Type 430 Stainless Steel
K	Type 441 Stainless Steel
P	Type 439 Stainless Steel
U	Type 29-4C Stainless Steel

Example:

DSD 36" length with inside diameter 14" made of 29-4C inner flue and SS441 outer casting.

DSD	14	L36	UK
Model	Dia.	Part	Material

DS 30° elbow with inside diameter 22" made of 316L.

DS	22	E30	B
Model	Dia.	Part	Material

DSD wall support for 8" diameter chimney made of stainless 439.

SSD	8	WSHD	P
Model	Dia.	Part	Material

Installation

Each DuraSeal vent length and component features our DuraLock system and Viton® o-ring gasket, which insure a gas- and water-tight system. Parts are easily pushed and fastened together instantly and effortlessly.

DuraSeal can be taken apart and easily reassembled, making inspection, maintenance or rerouting of DuraSeal systems simple and straightforward.

DuraSeal provides an extensive range of components and accessories, made of stainless steel, allowing any type of installation. On top of the common components, we also offer special parts that help simplify installation, such as the 2-degree elbow and 43-degree tee (simplifying pitching on a horizontal vent) or the 18" and 36" adjustable lengths (to help maximize ease of installation). Connecting the DSD to a heater is effortless with one of the many adapters approved by heating appliance manufacturers. Heating equipment can be operated immediately upon completing a DuraSeal installation, as no cure time or cleanup is required.

Note: If viton caulking is used at the boiler adapter or an adjustable length, there is a cure time of 24 hours.

When venting Category I, II, III, or IV appliances or type L vented appliances, DuraSeal must be used for the entire length of the system. Do not mix pipe, fittings, or joining methods from different manufacturers. Every vent system must be planned and installed for optimum performance and safety. The venting system must be free to expand and contract and must be supported in accordance with these instructions. (Check for unrestricted vent movement through walls, ceilings, and roof penetrations). Refer to the gas appliance manufacturer's instructions to determine venting requirements and limitations with respect to installation and use of the appliance. It is the responsibility of the installer to contact local building and fire officials concerning any installation restrictions and/or inspection requirements that may apply. Permits may be required before starting and installation.

- If required by the appliance manufacturer, a Drain Tee Cap must be located as close as possible to the appliance flue outlet. Depending on the arrangement of the vent, more than one drain may be required. Unless a Drain Tee Cap is supplied with the appliance, install a DuraSeal Drain Tee Cap.
- More than one Category II, III, or IV appliance may not be connected into the same vent system unless the appliance manufacturer specifically approved such a system and the appliance is designed for multiple venting.
- DuraSeal must not come in contact with plumbing or electrical systems.
- Maintain rated clearances to combustibles over the entire length of the vent system.
- DuraSeal shall not be routed into, through, or within any vent, such as an existing masonry or factory-built chimney that is connected to another appliance.

DSD & DSID Lengths

Use to vent category II, III and IV appliances.

Ø	Effective Length	Product Code DSD	Product Code DSID
4" to 24"	6-5/8"	DSDØL9	DSIDØL9
4" to 24"	9-5/8"	DSDØL12	DSIDØL12
3" to 24"	15-5/8"	DSDØL18	DSIDØL18
4" to 24"	21-5/8"	DSDØL24	DSIDØL24
4" to 24"	33-5/8"	DSDØL36	DSIDØL36
5" to 8"	45-5/8"	---	DSIDØL48
5" to 9"	45-5/8"	DSDØL48	---

Note: DSID 3", 9" and 24" not available.
 Note: DSDØL48 and DSIDØL48 only available in 316 material.

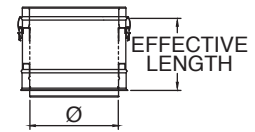

DSD & DSID Adjustable Lengths

Use to add length to straight length of DuraSeal pipe. Adds 2"–14" of length. Requires at least 4" overlap for a secure connection. Available in Custom Lengths.

Ø	Effective Length	Product Code DSD	Product Code DSID
3" to 24"	2" to 6-5/8"	DSDØAL9	DSIDØAL9
4" to 24"	2" to 15-5/8"	DSDØAL18	DSIDØAL18

Note: DSID 3", 9" and 24" not available.

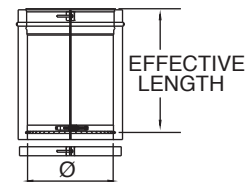

DSD & DSID Test Port Lengths

Use to test for proper appliance operation without penetrating the vent wall. Easy access to perform flue gas analysis. Test port plug included.

Ø	Effective Length	Product Code DSD	Product Code DSID
3" to 24"	6-5/8"	DSDØTPL	DSIDØTPL

Note: DSID 3", 9" and 24" not available.

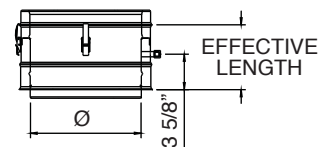

DSD & DSID Drain Lengths

Ø	Effective Length	Product Code DSD	Product Code DSID	K Factor
3" to 24"	6-5/8"	DSDØDL	DSIDØDL	0.25

Drain plug not included.
 Drain Ø4–Ø10, 1/4 NPT, 1/2 O.D
 Drain 12–Ø24, 1/2 NPT, 5/8 O.D
 Note: DSID 3", 9" and 24" not available.

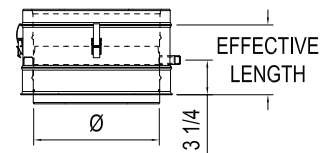
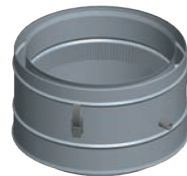

DSD & DSID Damper Lengths

Ø	Effective Length	Product Code DSD	Product Code DSID	K Factor
3" to 24"	21-5/8"	DSDØDAMP	DSIDØDAMP	0.60-9999

Note: DSID 3", 9" and 24" not available.

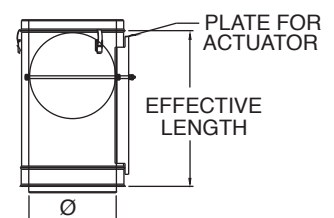

DSD & DSID Damper Lengths Short

Ø	Effective Length	Product Code DSD	Product Code DSID	K Factor
3" to 24"	6-5/8"	DSDØDAMPS	DSIDØDAMPS	0 to 9999

Note: DSID 3", 9" and 24" not available.

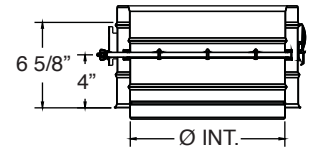
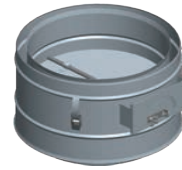

DSD K&W Fixed Blade Damper Lengths

Ø	Effective Length	Product Code DSD
6" to 18"	18"	DSDØKWDAMP

Note: Not available for DSID.

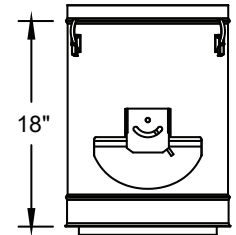

DSD Motorized Damper Lengths

Ø	Effective Length	Product Code DSD
3" to 18"	18"	DSDØMOTDAMP

Note: DSD 5", 7", 9", 11", 13", 15", and 17" not available.

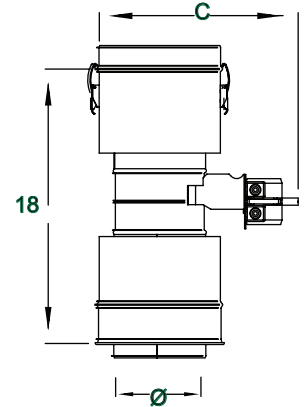

DSD & DSID Vent Flow Regulator

Ø	Effective Length	Product Code DSD	Product Code DSID	K Factor
3" to 24"	5-7/8"	DSDØVFR	DSIDØVFR	0 to 9999

Note: DSID 3", 9" and 24" not available.

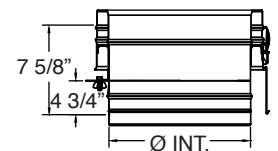
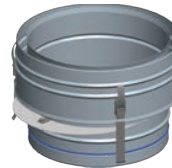

DSD Telescopic Lengths

Telescopic lengths do not require cutting to fit dimension.

Ø	Effective Length	Product Code DSD
4" to 24"	14" to 20"	DSDØLAT20
3" to 24"	20" to 32"	DSDØLAT32

Note: Not available for DSID.

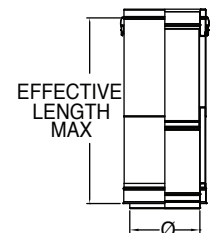

DSD 2-Degree Elbow

Use to facilitate the 2° pitch required in horizontal runs. Offsets obstructions as needed. Allows for better condensate management and less back pressure.

Ø	Offset	Rise	Product Code DSD	K Factor
3" to 5"	1/8"	7-3/4"	DSDØE2	.04
6" to 8"	1/8"	7-7/8"	DSDØE2	.04
9" to 12"	1/8"	8"	DSDØE2	.04
14"	1/8"	8-1/8"	DSD14E2	.03
16" to 18"	1/8"	8-1/4"	DSDØE2	.03
20" to 22"	1/8"	8-3/8"	DSDØE2	.03
24"	1/8"	8-1/2"	DSD24E2	.03

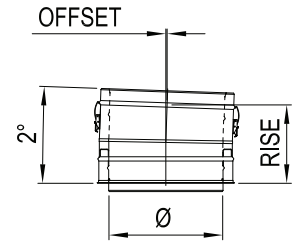

DSID 2-Degree Elbow

Use to facilitate the 2° pitch required in horizontal runs. Offsets obstructions as needed. Allows for better condensate management and less back pressure. 9" and 24" not available.

Ø	Offset	Rise	Product Code DSID	K Factor
4" to 5"	1/8"	7-3/4"	DSIDØE2	.04
6" to 8"	1/8"	7-7/8"	DSIDØE2	.04
10" to 12"	1/8"	8"	DSIDØE2	.04
14"	1/8"	8-1/8"	DSID14E2	.04
16" to 18"	1/8"	8-1/4"	DSIDØE2	.04
20" to 22"	1/8"	8-3/8"	DSIDØE2	.04

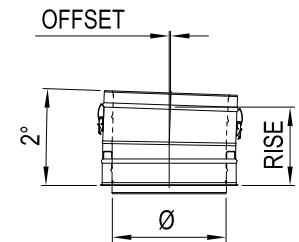

DSD 15-Degree Elbow

Offsets obstructions as needed. Allows for better condensate management and less back pressure.

Ø	Offset	Rise	Product Code DSD	K Factor
3"	1"	8-3/4"	DSD3E15	.31
4"	1"	8-3/4"	DSD4E15	.31
5"	1"	8-3/4"	DSD5E15	.30
6"	1-1/8"	9"	DSD6E15	.30
7"	1-1/8"	9-3/8"	DSD7E15	.29
8"	1-1/4"	9-5/8"	DSD8E15	.29
9"	1-1/4"	9-7/8"	DSD9E15	.28
10"	1-1/4"	10-1/8"	DSD10E15	.28
12"	1-3/8"	10-5/8"	DSD12E15	.27
14"	1-3/8"	11-1/8"	DSD14E15	.27
16"	1-1/2"	11-5/8"	DSD16E15	.26
18"	1-1/2"	12-1/8"	DSD18E15	.26
20"	1-5/8"	12-5/8"	DSD20E15	.26
22"	1-5/8"	13-1/4"	DSD22E15	.26
24"	1-3/4"	13-3/4"	DSD24E15	.26

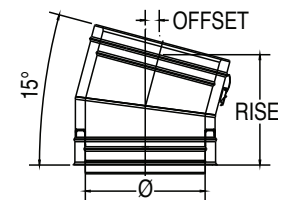

DSID 15-Degree Elbow

Offsets obstructions as needed. Allows for better condensate management and less back pressure. 9" and 24" not available.

Ø	Offset	Rise	Product Code DSID	K Factor
4"	1-1/8"	9"	DSID4E15	.31
5"	1-1/8"	9-3/8"	DSID5E15	0.3
6"	1-1/4"	9-5/8"	DSID6E15	0.3
7"	1-1/4"	9-7/8"	DSID7E15	0.29
8"	1-1/4"	10-1/8"	DSID8E15	0.29
10"	1-3/8"	10-5/8"	DSID10E15	0.28
12"	1-3/8"	11-1/8"	DSID12E15	0.27
14"	1-1/2"	11-5/8"	DSID14E15	0.27
16"	1-1/2"	12-1/8"	DSID16E15	0.26
18"	1-5/8"	12-5/8"	DSID18E15	0.26
20"	1-5/8"	13-1/4"	DSID20E15	0.26
22"	1-3/4"	13-3/4"	DSID22E15	0.26

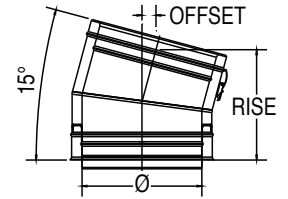
**DSD 30-Degree Elbow**

Offsets obstructions as needed. Allows for better condensate management and less back pressure.

Ø	Offset	Rise	Product Code DSD	K Factor
3"	2-3/8"	9-5/8"	DSD3E30	.65
4"	2-3/8"	9-5/8"	DSD4E30	.61
5"	2-3/8"	9-5/8"	DSD5E30	.60
6"	2-5/8"	10-1/8"	DSD6E30	.59
7"	2-3/4"	10-5/8"	DSD7E30	.58
8"	2-7/8"	11-1/8"	DSD8E30	.57
9"	3"	11-5/8"	DSD9E30	.56
10"	3-1/8"	12-1/8"	DSD10E30	.55
12"	3-3/8"	13-1/8"	DSD12E30	.54
14"	3-5/8"	14-1/8"	DSD14E30	.54
16"	3-7/8"	15-1/8"	DSD16E30	.53
18"	4-1/8"	16-1/8"	DSD18E30	.52
20"	4-1/2"	17-1/8"	DSD20E30	.52
22"	4-3/4"	18-1/8"	DSD22E30	.51
24"	5"	19-1/8"	DSD24E30	.51

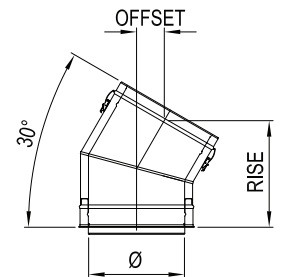

DSID 30-Degree Elbow

Offsets obstructions as needed. Allows for better condensate management and less back pressure. 9" and 24" not available.

Ø	Offset	Rise	Product Code DSID	K Factor
4"	2-5/8"	10-1/8"	DSID4E30	0.61
5"	2-3/4"	10-5/8"	DSID5E30	0.60
6"	2-7/8"	11-1/8"	DSID6E30	0.59
7"	3"	11-5/8"	DSID7E30	0.58
8"	3-1/8"	12-1/8"	DSID8E30	0.57
10"	3-3/8"	13-1/8"	DSID10E30	0.55
12"	3-5/8"	14-1/8"	DSID12E30	0.54
14"	3-7/8"	15-1/8"	DSID14E30	0.54
16"	4-1/8"	16-1/8"	DSID16E30	0.53
18"	4-1/2"	17-1/8"	DSID18E30	0.52
20"	4-3/4"	18-1/8"	DSID20E30	0.52
22"	5"	19-1/8"	DSID22E30	0.51

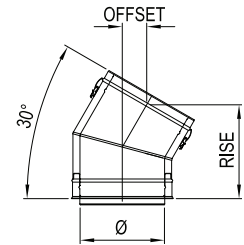

DSD 45-Degree Elbow

Offsets obstructions as needed. Allows for better condensate management and less back pressure.

Ø	Offset	Rise	Product Code DSD	K Factor
3"	3-3/4"	9-1/2"	DSD3E45	.30
4" to 5"	4"	10-1/8"	DSDØE45	.26
6"	4-1/4"	10-7/8"	DSD6E45	.17
7"	4-1/2"	11-1/2"	DSD7E45	.16
8"	4-7/8"	12-1/4"	DSD8E45	.14
9"	5-1/8"	13"	DSD9E45	.13
10"	5-3/8"	13-5/8"	DSD10E45	.12
12"	6"	15-1/8"	DSD12E45	.11
14"	6-5/8"	16-1/2"	DSD14E45	.11
16"	7-1/8"	17-7/8"	DSD16E45	.10
18"	7-3/4"	19-3/8"	DSD18E45	.09
20"	8-3/8"	20-3/4"	DSD20E45	.08
22"	8-7/8"	22-1/8"	DSD22E45	.08
24"	9-1/2"	23-5/8"	DSD24E45	.08

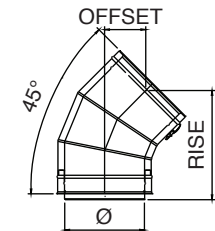

DSID 45-Degree Elbow

Offsets obstructions as needed. Allows for better condensate management and less back pressure. 9" and 24" not available.

Ø	Offset	Rise	Product Code DSID	K Factor
4"	4-1/4"	10-7/8"	DSID4E45	0.26
5"	4-1/2"	11-1/2"	DSID5E45	0.22
6"	4-7/8"	12-1/4"	DSID6E45	0.17
7"	5-1/8"	13"	DSID7E45	0.16
8"	5-3/8"	13-5/8"	DSID8E45	0.14
10"	6"	15-1/8"	DSID10E45	0.12
12"	6-5/8"	16-1/2"	DSID12E45	0.11
14"	7-1/8"	17-7/8"	DSID14E45	0.11
16"	7-3/4"	19-3/8"	DSID16E45	0.1
18"	8-3/8"	20-3/4"	DSID18E45	0.09
20"	8-7/8"	22-1/8"	DSID20E45	0.08
22"	9-1/2"	23-5/8"	DSID22E45	0.08

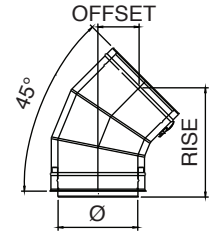

DSD 88-Degree Elbow

Use to transition from a vertical to a horizontal run. Stabilizes a 2° pitch towards the condensate drain for good condensate management.

Ø	Offset	Rise	Product Code DSD	K Factor
3"	9"	9-1/4"	DSD3E88	.60
4" to 5"	9"	9-1/4"	DSDØE88	.54
6"	9-1/4"	10-1/4"	DSD6E88	.42
7"	10-1/4"	11-1/4"	DSD7E88	.39
8"	11-1/4"	12-1/4"	DSD8E88	.37
9"	12-1/4"	13-1/4"	DSD9E88	.34
10"	13-1/8"	14-1/4"	DSD10E88	.32
12"	15-1/8"	16-1/4"	DSD12E88	.29
14"	17"	18-1/4"	DSD14E88	.27
16"	19"	20-1/4"	DSD16E88	.25
18"	20-7/8"	22-1/4"	DSD18E88	.24
20"	22-7/8"	24-1/4"	DSD20E88	.23
22"	24-3/4"	26-1/4"	DSD22E88	.21
24"	26-5/8"	28-1/4"	DSD24E88	.20

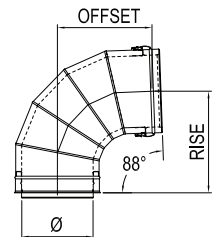

DSID 88-Degree Elbow

Use to transition from a vertical to a horizontal run. Stabilizes a 2° pitch towards the condensate drain for good condensate management. 9" and 24" not available.

Ø	Offset	Rise	Product Code DSID	K Factor
4" to 5"	9"	9-1/4"	DSIDØE88	.54
6"	9-1/4"	10-1/4"	DSID6E88	.42
7"	10-1/4"	11-1/4"	DSID7E88	.39
8"	11-1/4"	12-1/4"	DSID8E88	.37
10"	13-1/8"	14-1/4"	DSID10E88	.32
12"	15-1/8"	16-1/4"	DSID12E88	.29
14"	17"	18-1/4"	DSID14E88	.27
16"	19"	20-1/4"	DSID16E88	.25
18"	20-7/8"	22-1/4"	DSID18E88	.24
20"	22-7/8"	24-1/4"	DSID20E88	.23
22"	24-3/4"	26-1/4"	DSID22E88	.21

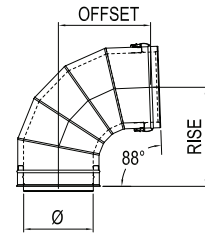
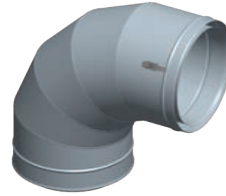

DSD 90-Degree Elbow

Use to go from horizontal to vertical runs or vertical to horizontal runs. Use to turn vent 90°.

Ø	Offset	Rise	Product Code DSD	K Factor
3"	8-1/2"	9-1/8"	DSD3E90	.60
4" to 5"	8-1/2"	9-1/8"	DSDØE90	.54
6"	9-1/2"	10-1/8"	DSD6E90	.42
7"	10-1/2"	11-1/8"	DSD7E90	.39
8"	11-1/2"	12-1/8"	DSD8E90	.37
9"	12-1/2"	13-1/8"	DSD9E90	.34
10"	13-1/2"	14-1/8"	DSD10E90	.32
12"	15-1/2"	16-1/8"	DSD12E90	.29
14"	17-1/2"	18-1/8"	DSD14E90	.27
16"	19-1/2"	20-1/8"	DSD16E90	.25
18"	21-1/2"	22-1/8"	DSD18E90	.24
20"	23-1/2"	24-1/8"	DSD20E90	.23
22"	25-1/2"	26-1/8"	DSD22E90	.21
24"	27-1/2"	28-1/8"	DSD24E90	.20

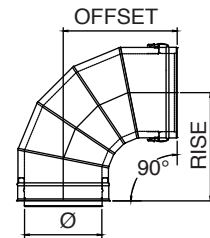
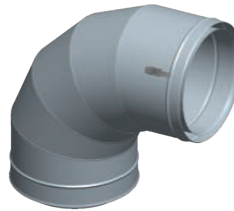

DSID 90-Degree Elbow

Use to go from horizontal to vertical runs or vertical to horizontal runs. Use to turn vent 90°. 9" and 24" not available.

Ø	Offset	Rise	Product Code DSID	K Factor
4"	9-1/2"	10-1/8"	DSID4E90	0.54
5"	10-1/2"	11-1/8"	DSID5E90	0.48
6"	11-1/2"	12-1/8"	DSID6E90	0.42
7"	12-1/2"	13-1/8"	DSID7E90	0.39
8"	13-1/2"	14-1/8"	DSID8E90	0.37
10"	15-1/2"	16-1/8"	DSID10E90	0.32
12"	17-1/2"	18-1/8"	DSID12E90	0.29
14"	19-1/2"	20-1/8"	DSID14E90	0.27
16"	21-1/2"	22-1/8"	DSID16E90	0.25
18"	23-1/2"	24-1/8"	DSID18E90	0.24
20"	25-1/2"	26-1/8"	DSID20E90	0.23
22"	27-1/2"	28-1/8"	DSID22E90	0.21

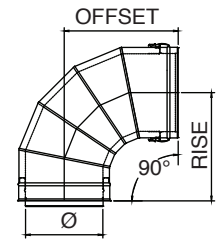
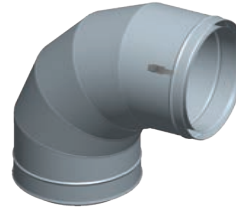

DSD & DSID Venting Tees

DSD 43-Degree Tee

Use in place of any tee for a 43° angle instead of 90°; can be used as a manifold connection to gang multiple boilers into a common vent.

Ø	Height	Offset	Rise	Product Code DSD	K Factor
3"	15-1/2"	7-5/8"	13-3/8"	DSD3T43	0.4
4"	16-1/2"	8-1/4"	13-3/8"	DSD4T43	0.4
5"	18-1/2"	8-7/8"	14-3/8"	DSD5T43	0.4
6"	19-1/2"	9-5/8"	15-3/8"	DSD6T43	0.4
7"	20-1/2"	10-1/4"	16-1/4"	DSD7T43	0.4
8"	22-1/2"	11-5/8"	18"	DSD8T43	0.4
9"	23-1/2"	12-1/4"	18-7/8"	DSD9T43	0.4
10"	25-1/2"	13"	19-3/4"	DSD10T43	0.4
12"	28-1/2"	15"	22-3/8"	DSD12T43	0.4
14"	31-1/2"	16-3/8"	24-1/4"	DSD14T43	0.4
16"	33-1/2"	18-1/2"	26-1/4"	DSD16T43	0.4
18"	38-1/4"	20-1/2"	29-3/8"	DSD18T43	0.4
20"	42-1/4"	23-7/8"	33-1/2"	DSD20T43	0.4
22"	45-1/4"	23-7/8"	33-7/8"	DSD22T43	0.4
24"	51-1/4"	27-7/8"	38-1/2"	DSD24T43	0.4

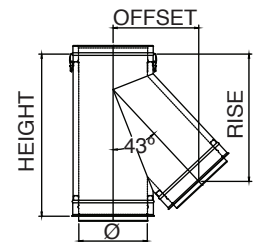

Available with smaller snout and custom height.

DSID 43-Degree Tee

Use in place of any tee for a 43° angle instead of 90°; can be used as a manifold connection to gang multiple boilers into a common vent. 9" and 24" not available.

Ø	Height	Offset	Rise	Product Code DSID	K Factor
4"	19-1/2"	9-5/8"	15-3/8"	DSID4T43	0.4
5"	20-1/2"	10-1/4"	16-1/4"	DSID5T43	0.4
6"	22-1/2"	11-5/8"	18"	DSID6T43	0.4
7"	23-1/2"	12-1/4"	18-7/8"	DSID7T43	0.4
8"	25-1/2"	13"	19-3/4"	DSID8T43	0.4
10"	28-1/2"	15"	22-3/8"	DSID10T43	0.4
12"	31-1/2"	16-3/8"	24-1/4"	DSID12T43	0.4
14"	33-1/2"	18-1/2"	26-1/4"	DSID14T43	0.4
16"	38-1/4"	20-1/2"	29-3/8"	DSID16T43	0.4
18"	42-1/4"	23-7/8"	33-1/2"	DSID18T43	0.4
20"	45-1/4"	23-7/8"	33-7/8"	DSID20T43	0.4
22"	51-1/4"	27-7/8"	38-1/2"	DSID22T43	0.4

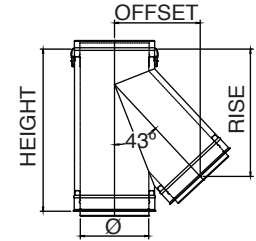

Available with smaller snout and custom height.

DSD 45-Degree Tee

Use in place of any tee for a 45° angle instead of 90°; can be used as a manifold connection to gang multiple boilers into a common vent.

Ø	Height	Offset	Rise	Product Code DSD	K Factor
3"	15-1/2"	7-5/8"	13-1/4"	DSD3T45	0.4
4"	16-1/2"	8-1/2"	13-1/4"	DSD4T45	0.4
5"	18-1/2"	9-1/4"	14-1/8"	DSD5T45	0.4
6"	19-1/2"	9-7/8"	15-1/8"	DSD6T45	0.4
7"	20-1/2"	10-5/8"	16"	DSD7T45	0.4
8"	22-1/2"	12"	17-5/8"	DSD8T45	0.4
9"	23-1/2"	12-3/4"	18-1/2"	DSD9T45	0.4
10"	25-1/2"	13-1/2"	19-1/2"	DSD10T45	0.4
12"	28-1/2"	15-5/8"	22"	DSD12T45	0.4
14"	31-1/2"	17"	23-7/8"	DSD14T45	0.4
16"	33-1/2"	19-1/8"	26-3/8"	DSD16T45	0.4
18"	38-1/4"	21-1/4"	28-7/8"	DSD18T45	0.4
20"	42-1/4"	24-3/4"	32-7/8"	DSD20T45	0.4
22"	45-1/4"	24-3/4"	33-1/4"	DSD22T45	0.4
24"	51-1/4"	28-7/8"	37-3/4"	DSD24T45	0.4

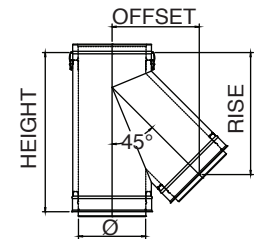

Available with smaller snout and custom height.

DSID 45-Degree Tee

Use in place of any tee for a 45° angle instead of 90°; can be used as a manifold connection to gang multiple boilers into a common vent. 9" and 24" not available.

Ø	Height	Offset	Rise	Product Code DSID	K Factor
4"	19-1/2"	9-7/8"	14-1/8"	DSID4T45	0.4
5"	20-1/2"	10-5/8"	14-1/8"	DSID5T45	0.4
6"	22-1/2"	12"	15-1/8"	DSID6T45	0.4
7"	23-1/2"	12-3/4"	16"	DSID7T45	0.4
8"	25-1/2"	13-1/2"	17-5/8"	DSID8T45	0.4
10"	28-1/2"	15-5/8"	19-1/2"	DSID10T45	0.4
12"	31-1/2"	17"	22"	DSID12T45	0.4
14"	33-1/2"	19-1/8"	23-7/8"	DSID14T45	0.4
16"	38-1/4"	21-1/4"	26-3/8"	DSID16T45	0.4
18"	42-1/4"	24-3/4"	28-7/8"	DSID18T45	0.4
20"	45-1/4"	24-3/4"	32-7/8"	DSID20T45	0.4
22"	51-1/4"	28-7/8"	33-1/4"	DSID22T45	0.4

Available with smaller snout and custom height.

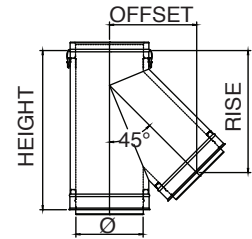

DSD 88-Degree Tee

Use for an 88° offset, or to combine connections from two or more appliances into a common vent. Can also use as a condensate management point when used in conjunction with drain fitting. All Standard Tees are completely welded.

Ø	Height	Offset	Rise	Product Code DSD	K Factor
3"	12-1/2"	7"	6-1/4"	DSD3T88	1.21
4"	13-1/2"	7"	6-5/8"	DSD4T88	1.21
5"	14-1/2"	8"	7-1/4"	DSD5T88	1.21
6"	15-1/2"	8"	7-5/8"	DSD6T88	1.21
7"	16-1/2"	9"	8-1/4"	DSD7T88	1.21
8"	17-1/2"	9"	8-5/8"	DSD8T88	1.21
9"	18-1/2"	10"	9-1/4"	DSD9T88	1.21
10"	19-1/2"	10"	9-5/8"	DSD10T88	1.21
12"	21-1/2"	11"	10-5/8"	DSD12T88	1.21
14"	23-1/2"	12"	11-5/8"	DSD14T88	1.21
16"	25-1/2"	13"	12-5/8"	DSD16T88	1.21
18"	27-1/2"	14"	13-5/8"	DSD18T88	1.21
20"	29-1/2"	15"	14-5/8"	DSD20T88	1.21
22"	31-1/2"	16"	15-5/8"	DSD22T88	1.21
24"	33-1/2"	17"	16-5/8"	DSD24T88	1.21

Available with smaller snout and custom height.

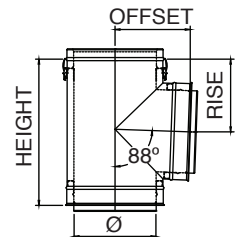

DSID 88-Degree Tee

Use for an 88° offset, or to combine connections from two or more appliances into a common vent. Can also use as a condensate management point when used in conjunction with drain fitting. All Standard Tees are completely welded. 9" and 24" not available.

Ø	Height	Offset	Rise	Product Code DSID	K Factor
4"	15-1/2"	8"	7-5/8"	DSID4T88	1.21
5"	16-1/2"	9"	8-1/4"	DSID5T88	1.21
6"	17-1/2"	9"	8-5/8"	DSID6T88	1.21
7"	18-1/2"	10"	9-1/4"	DSID7T88	1.21
8"	19-1/2"	10"	9-5/8"	DSID8T88	1.21
10"	21-1/2"	11"	10-5/8"	DSID10T88	1.21
12"	23-1/2"	12"	11-5/8"	DSID12T88	1.21
14"	25-1/2"	13"	12-5/8"	DSID14T88	1.21
16"	27-1/2"	14"	13-5/8"	DSID16T88	1.21
18"	29-1/2"	15"	14-5/8"	DSID18T88	1.21
20"	31-1/2"	16"	15-5/8"	DSID20T88	1.21
22"	33-1/2"	17"	16-5/8"	DSID22T88	1.21

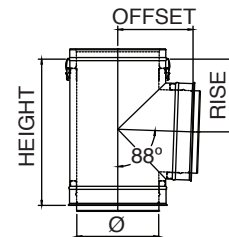

Available with smaller snout and custom height.

DSD 90-Degree Tee

Use for a 90° offset, or to combine connections from two or more appliances into a common vent. Can also use as a condensate management point when used in conjunction with drain fitting. All Standard Tees are completely welded.

Ø	Height	Offset	Rise	Product Code DSD	K Factor
3"	12-1/2"	7"	6-1/4"	DSD3T90	1.21
4"	13-1/2"	7"	6-1/2"	DSD4T90	1.21
5"	14-1/2"	8"	7"	DSD5T90	1.21
6"	15-1/2"	8"	7-1/2"	DSD6T90	1.21
7"	16-1/2"	9"	8"	DSD7T90	1.21
8"	17-1/2"	9"	8-1/2"	DSD8T90	1.21
9"	18-1/2"	10"	9"	DSD9T90	1.21
10"	19-1/2"	10"	9-1/2"	DSD10T90	1.21
12"	21-1/2"	11"	10-1/2"	DSD12T90	1.21
14"	23-1/2"	12"	11-1/2"	DSD14T90	1.21
16"	25-1/2"	13"	12-1/2"	DSD16T90	1.21
18"	27-1/2"	14"	13-1/2"	DSD18T90	1.21
20"	29-1/2"	15"	14-1/2"	DSD20T90	1.21
22"	31-1/2"	16"	15-1/2"	DSD22T90	1.21
24"	33-1/2"	17"	16-1/2"	DSD24T90	1.21

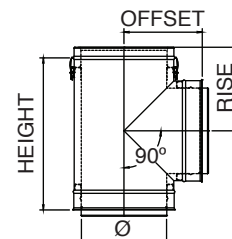

Available with smaller snout and custom height.

DSID 90-Degree Tee

Use for a 90° offset, or to combine connections from two or more appliances into a common vent. Can also use as a condensate management point when used in conjunction with drain fitting. All Standard Tees are completely welded. 9" and 24" not available.

Ø	Height	Offset	Rise	Product Code DSID	K Factor
4"	15-1/2"	8"	7-1/2"	DSID4T90	1.21
5"	16-1/2"	9"	8"	DSID5T90	1.21
6"	17-1/2"	9"	8-1/2"	DSID6T90	1.21
7"	18-1/2"	10"	9"	DSID7T90	1.21
8"	19-1/2"	10"	9-1/2"	DSID8T90	1.21
10"	21-1/2"	11"	10-1/2"	DSID10T90	1.21
12"	23-1/2"	12"	11-1/2"	DSID12T90	1.21
14"	25-1/2"	13"	12-1/2"	DSID14T90	1.21
16"	27-1/2"	14"	13-1/2"	DSID16T90	1.21
18"	29-1/2"	15"	14-1/2"	DSID18T90	1.21
20"	31-1/2"	16"	15-1/2"	DSID20T90	1.21
22"	33-1/2"	17"	16-1/2"	DSID22T90	1.21

Available with smaller snout and custom height.

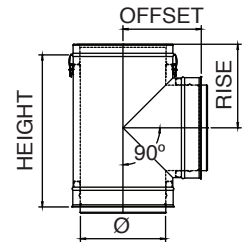
**DSD 90-Degree Tee Y**

Ø	Offset	Rise	Product Code DSD	K Factor
3"	4.5"	9-5/8"	DSD3TY90	0.6
4"	5"	10-3/8"	DSD4TY90	0.6
5" and 6"	5-5/8"	11-1/8"	DSDØTY90	0.6
7" and 8"	6-3/8"	11-3/4"	DSDØTY90	0.6
9" and 10"	7-1/8"	13-1/2"	DSDØTY90	0.6
12"	7-3/4"	14-1/4"	DSD12TY90	0.6
14"	8-1/2"	15-7/8"	DSD14TY90	0.6
16"	9-1/4"	17-5/8"	DSD16TY90	0.6
18"	9-7/8"	18-3/8"	DSD18TY90	0.6
20"	10-5/8"	21"	DSD20TY90	0.6
22"	11-3/8"	21-3/4"	DSD22TY90	0.6
24"	12"	22-1/2"	DSD24TY90	0.6

Available with smaller snout.

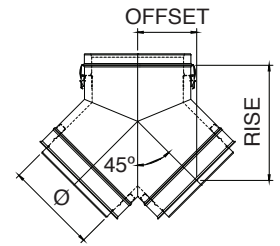

DSID 90-Degree Tee Y

Ø	Offset	Rise	Product Code DSID	K Factor
4"	5-5/8"	11-1/8"	DSID4TY90	0.6
5" to 6"	6-3/8"	11-3/4"	DSIDØTY90	0.6
7" to 8"	7-1/8"	13-1/2"	DSIDØTY90	0.6
10"	7-3/4"	14-1/4"	DSID10TY90	0.6
12"	8-1/2"	15-7/8"	DSID12TY90	0.6
14"	9-1/4"	17-5/8"	DSID14TY90	0.6
16"	9-7/8"	18-3/8"	DSID16TY90	0.6
18"	10-5/8"	21"	DSID18TY90	0.6
20"	11-3/8"	21-3/4"	DSID20TY90	0.6
22"	12"	22-1/2"	DSID22TY90	0.6

Available with smaller snout. 9" and 24" not available.

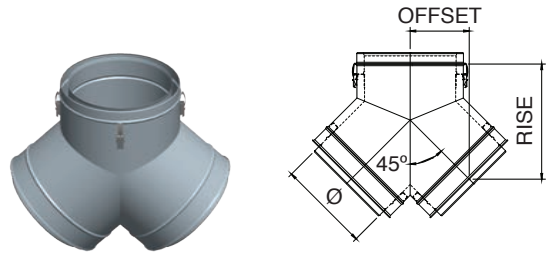

DSD Lateral TEE

Use to transition from horizontal to vertical with improved flue gas flow.

Ø	Height	Offset	Rise	Product Code DSD	K Factor
3"	13-3/8"	11-1/8"	9"	DSD3BT	0.55
4"	14-3/8"	11-5/8"	10"	DSD4BT	0.55
5"	16-3/8"	12-1/4"	11"	DSD5BT	0.55
6"	17-3/8"	13-3/4"	12-1/4"	DSD6BT	0.55
7"	19-3/8"	14-3/4"	13-1/4"	DSD7BT	0.55
8"	20-3/8"	16"	14-3/8"	DSD8BT	0.55
9"	23-3/8"	14-1/4"	14-1/4"	DSD9BT	0.55
10"	25-3/8"	15-1/4"	15-1/4"	DSD10BT	0.55
12"	27-3/8"	16-7/8"	17"	DSD12BT	0.55
14"	30-3/8"	18-7/8"	18-7/8"	DSD14BT	0.55
16"	33-3/8"	20-3/4"	20-3/4"	DSD16BT	0.55
18"	38-1/8"	22-1/2"	22-1/2"	DSD18BT	0.55
20"	42-1/8"	24-3/4"	24-3/8"	DSD20BT	0.55
22"	45-1/8"	26-1/4"	26-1/4"	DSD22BT	0.55
24"	51-1/8"	28"	28-1/8"	DSD24BT	0.55

Available with smaller snout and custom height.

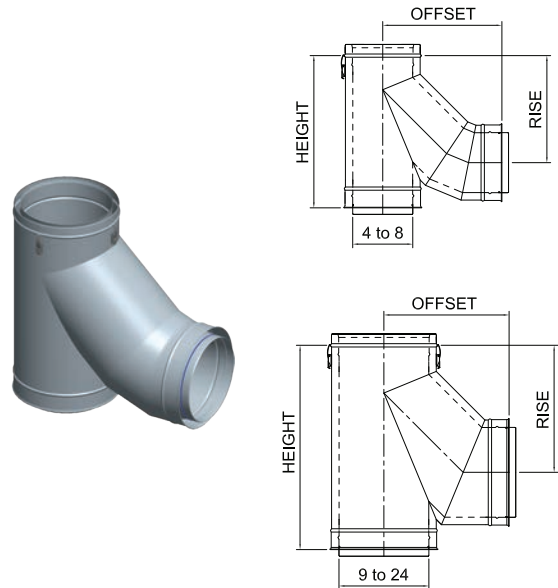

DSID Lateral TEE

Use to transition from horizontal to vertical with improved flue gas flow. 9" and 24" not available.

Ø	Height	Offset	Rise	Product Code DSID	K Factor
4"	17-3/8"	13-3/4"	12-1/4"	DSID4BT	0.55
5"	19-3/8"	14-3/4"	13-1/4"	DSID5BT	0.55
6"	20-3/8"	16"	14-3/8"	DSID6BT	0.55
7"	23-3/8"	14-1/4"	14-1/4"	DSID7BT	0.55
8"	25-3/8"	15-1/4"	15-1/4"	DSID8BT	0.55
10"	27-3/8"	16-7/8"	17"	DSID10BT	0.55
12"	30-3/8"	18-7/8"	18-7/8"	DSID12BT	0.55
14"	33-3/8"	20-3/4"	20-3/4"	DSID14BT	0.55
16"	38-1/8"	22-1/2"	22-1/2"	DSID16BT	0.55
18"	42-1/8"	24-3/4"	24-3/8"	DSID18BT	0.55
20"	45-1/8"	26-1/4"	26-1/4"	DSID20BT	0.55
22"	51-1/8"	28"	28-1/8"	DSID22BT	0.55

Available with smaller snout and custom height.

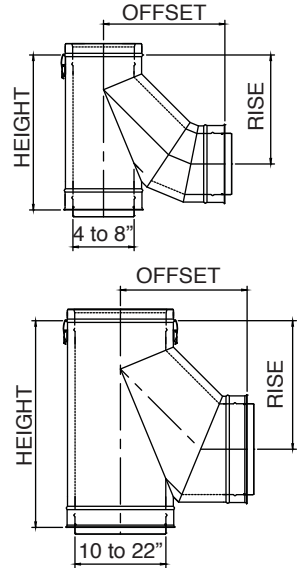

DSD Lateral TEE 88-Degree

Use to transition from horizontal to vertical with improved flue gas flow.

Ø	Height	Offset	Rise	Product Code DSD	K Factor
3"	13-3/8"	11-1/8"	9"	DSD3BT88	0.55
4"	14-3/8"	11-5/8"	10-1/4"	DSD4BT88	0.55
5"	16-3/8"	12-1/4"	11-3/8"	DSD5BT88	0.55
6"	17-3/8"	13-3/4"	12-3/4"	DSD6BT88	0.55
7"	19-3/8"	14-7/8"	13-3/4"	DSD7BT88	0.55
8"	20-3/8"	16-1/8"	15"	DSD8BT88	0.55
9"	23-3/8"	14-1/2"	15-1/4"	DSD9BT88	0.55
10"	25-3/8"	15-3/8"	16-1/8"	DSD10BT88	0.55
12"	28-3/8"	17"	17-7/8"	DSD12BT88	0.55
14"	31-3/8"	19-1/8"	20-1/8"	DSD14BT88	0.55
16"	33-3/8"	21"	22"	DSD16BT88	0.55
18"	38-3/8"	22-7/8"	24"	DSD18BT88	0.55
20"	42-1/8"	24-3/4"	26"	DSD20BT88	0.55
22"	45-1/8"	26-5/8"	28"	DSD22BT88	0.55
24"	51-1/8"	28-1/2"	29-7/8"	DSD24BT88	0.55

Available with smaller snout and custom height.

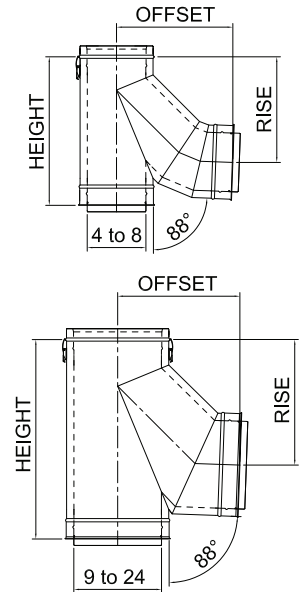

DSID Lateral TEE 88-Degree

Use to transition from horizontal to vertical with improved flue gas flow. 9" and 24" not available.

Ø	Height	Offset	Rise	Product Code DSID	K Factor
4"	17-3/8"	13-3/4"	12-3/4"	DSID4BT88	0.55
5"	19-3/8"	14-7/8"	13-3/4"	DSID5BT88	0.55
6"	20-3/8"	16-1/8"	15"	DSID6BT88	0.55
7"	23-3/8"	14-1/2"	15-1/4"	DSID7BT88	0.55
8"	25-3/8"	15-3/8"	16-1/8"	DSID8BT88	0.55
10"	28-3/8"	17"	17-7/8"	DSID10BT88	0.55
12"	31-3/8"	19-1/8"	20-1/8"	DSID12BT88	0.55
14"	33-3/8"	21"	22"	DSID14BT88	0.55
16"	38-3/8"	22-7/8"	24"	DSID16BT88	0.55
18"	42-1/8"	24-3/4"	26"	DSID18BT88	0.55
20"	45-1/8"	26-5/8"	28"	DSID20BT88	0.55
22"	51-1/8"	28-1/2"	29-7/8"	DSID22BT88	0.55

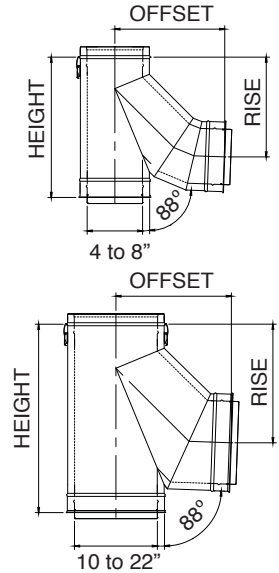

DSD Barometric Tee

Ø	Height	Offset	Rise	Product Code DSD	K Factor
3"	12-1/2"	8"	6"	DSD3BMT	0.2
4"	13-1/2"	8"	6-1/2"	DSD4BMT	0.2
5"	14-1/2"	9"	7"	DSD5BMT	0.2
6"	15-1/2"	9"	7-1/2"	DSD6BMT	0.2
7"	16-1/2"	10"	8"	DSD7BMT	0.2
8"	17-1/2"	10"	8-1/2"	DSD8BMT	0.2
9"	18-1/2"	11"	9"	DSD9BMT	0.2
10"	19-1/2"	11"	9-1/2"	DSD10BMT	0.2
12"	21-1/2"	12"	10-1/2"	DSD12BMT	0.2
14"	23-1/2"	13"	11-1/2"	DSD14BMT	0.2
16"	25-1/2"	14"	12-1/2"	DSD16BMT	0.2
18"	27-1/2"	15"	13-1/2"	DSD18BMT	0.2
20"	29-1/2"	16"	14-1/2"	DSD20BMT	0.2
22"	31-1/2"	17"	15-1/2"	DSD22BMT	0.2
24"	33-1/2"	18"	16-1/2"	DSD24BMT	0.2

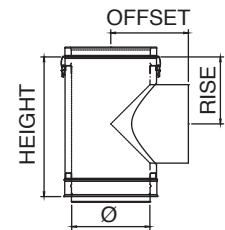

Available with smaller snout and custom height.

DSID Barometric Tee

Ø	Height	Offset	Rise	Product Code DSID	K Factor
4"	15-1/2"	9"	7-1/2"	DSID4BMT	0.2
5"	16-1/2"	10"	8"	DSID5BMT	0.2
6"	17-1/2"	10"	8-1/2"	DSID6BMT	0.2
7"	18-1/2"	11"	9"	DSID7BMT	0.2
8"	19-1/2"	11"	9-1/2"	DSID8BMT	0.2
10"	21-1/2"	12"	10-1/2"	DSID10BMT	0.2
12"	23-1/2"	13"	11-1/2"	DSID12BMT	0.2
14"	25-1/2"	14"	12-1/2"	DSID14BMT	0.2
16"	27-1/2"	15"	13-1/2"	DSID16BMT	0.2
18"	29-1/2"	16"	14-1/2"	DSID18BMT	0.2
20"	31-1/2"	17"	15-1/2"	DSID20BMT	0.2
22"	33-1/2"	18"	16-1/2"	DSID22BMT	0.2

Available with smaller snout and custom height. 9" and 24" not available.

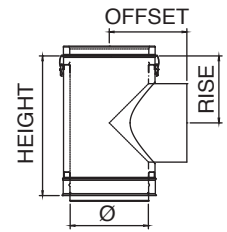

DSD & DSID Venting Accessories

DSD & DSID Tee Cap

Use to cap Standard Tee, Branch Tee or Boot Tee. Remove Tee Cap to inspect the system; clean out debris or collected condensate.

Ø	Height	Product Code DSD	Product Code DSID
3" to 24"	4-1/8"	DSDØTC	DSIDØTC

Note: DSID 3", 9" and 24" not available.

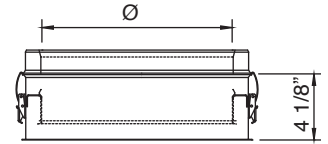

DSD & DSID Drain Tee Cap

Ø	Height	Product Code DSD	Product Code DSID
3" to 24"	4-1/8"	DSDØDTC	DSIDØDTC

Drain plug not included.
 Drain Ø4 – Ø10, 1/4 NPT, 1/2 O.D.
 Drain Ø12 – Ø24, 3/8 NPT, 5/8 O.D.

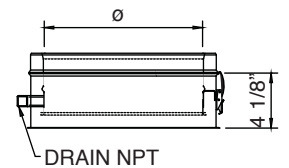

DSD & DSID Barometric Tee Cap

Ø	Height	Product Code SSD	Product Code SSID
3" to 24"	3-1/2"	DSDØBMT	DSIDØBMT



DSD & DSID Tapered Increaser

Use to increase vent diameter. Creates a smooth transition for an undrruptive flow. Available in custom size combinations.

Ø	ØB Available	Height	Product Code DSD	Product Code DSID	K Factor
3" to 9"	Ø+1"	12-7/16"	DSDØTIN(ØB)	DSIDØTIN(ØB)	0.05
4" to 22"	Ø+2"	13-7/16"	DSDØTIN(ØB)	DSIDØTIN(ØB)	0.10
4" to 9"	Ø+3"	14-7/16"	DSDØTIN(ØB)	DSIDØTIN(ØB)	0.15
4" to 20"	Ø+4"	15-7/16"	DSDØTIN(ØB)	DSIDØTIN(ØB)	0.20
4" to 7"	Ø+5"	16-7/16"	DSDØTIN(ØB)	DSIDØTIN(ØB)	0.25
4" to 18"	Ø+6"	17-7/16"	DSDØTIN(ØB)	DSIDØTIN(ØB)	0.30

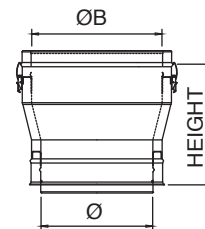

Note: DSID 9" and 24" not available.

DSD & DSID Step Increaser

Use to increase vent diameter when space constraints are an issue. Available in custom size combinations.

Ø	ØB Available	Height	Product Code DSD	Product Code DSID	K Factor
4" to 22"	5" to 24"	8"	DSDØSIN(ØB)	DSIDØSIN(ØB)	$KØ = (1-X^2)^2$ $KØB = KØ/X^4$ where $X = Ø/ØB$

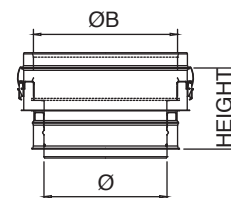

Note: DSID 3", 9" and 24" not available.

DSD & DSID Eccentric Tapered Increaser

Use to transition to a larger diameter pipe. Prevents condensate puddling when used on horizontal runs. Aids in reducing formation of condensates. Maximum 10" difference between diameter increase size on both sizes. Available in custom size combinations.

Ø	ØB Available	Height	Offset	Product Code DSD	Product Code DSID	K Factor
3" to 9"	Ø+1"	12-1/2"	1/2"	DSDØETIN(ØB)	DSIDØETIN(ØB)	0.05
4" to 22"	Ø+2"	13-1/2"	1"	DSDØETIN(ØB)	DSIDØETIN(ØB)	0.10
4" to 9"	Ø+3"	14-1/2"	1-1/2"	DSDØETIN(ØB)	DSIDØETIN(ØB)	0.15
4" to 20"	Ø+4"	15-1/2"	2"	DSDØETIN(ØB)	DSIDØETIN(ØB)	0.20
4" to 7"	Ø+5"	16-1/2"	2-1/2"	DSDØETIN(ØB)	DSIDØETIN(ØB)	0.25
4" to 18"	Ø+6"	17-1/2"	3"	DSDØETIN(ØB)	DSIDØETIN(ØB)	0.30

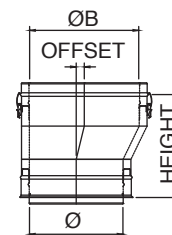

Note: DSID 3", 9" and 24" not available.

DSD & DSID Eccentric Step Increaser

Ø	ØB Available	Height	Offset	Product Code DSD	Product Code DSID	K Factor
3" to 22"	5" to 24"	8"	$(\text{ØB}-\text{Ø})/2$	DSDØESIN(ØB)	DSIDØESIN(ØB)	$K\text{Ø} = (1-X^2)^2$ $K\text{ØB} = K\text{Ø}/X^4$ where $X = \text{Ø}/\text{ØB}$

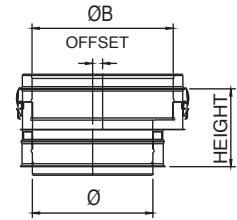

Note: DSID 3", 9" and 24" not available.

DSD & DSID Tapered Reducer

Ø	ØB Available	Height	Product Code DSD	Product Code DSID	K Factor
5" to 10"	Ø-1"	12-7/16"	DSDØTRD(ØB)	DSIDØTRD(ØB)	0.07
6" to 24"	Ø-2"	13-7/16"	DSDØTRD(ØB)	DSIDØTRD(ØB)	0.09
6" to 12"	Ø-3"	14-7/16"	DSDØTRD(ØB)	DSIDØTRD(ØB)	0.11
8" to 24"	Ø-4"	15-7/16"	DSDØTRD(ØB)	DSIDØTRD(ØB)	0.13
9" to 24"	Ø-5"	16-7/16"	DSDØTRD(ØB)	DSIDØTRD(ØB)	0.15
10" to 24"	Ø-6"	17-7/16"	DSDØTRD(ØB)	DSIDØTRD(ØB)	0.17

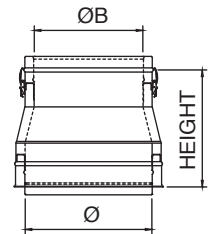

Note: DSID 9" and 24" not available.

DSD & DSID Step Reducer

Ø	ØB Available	Height	Product Code DSD	Product Code DSID	K Factor
5" to 24"	4" to 22"	8"	DSDØSRD(ØB)	DSIDØSRD(ØB)	$K\text{ØB} = 0.5(1-X^2)$ $K\text{Ø} = K\text{ØB}/X^4$ where $X = \text{ØB}/\text{Ø}$

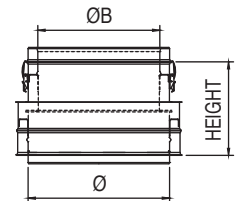

Note: DSID 9" and 24" not available.

DSD & DSID Eccentric Tapered Reducer

Ø	ØB Available	Height	Offset	Product Code DSD	Product Code DSID	K Factor
5" to 10"	Ø-1"	12-1/2"	1/2"	DSDØETRD(ØB)	DSIDØETRD(ØB)	0.07
6" to 24"	Ø-2"	13-1/2"	1"	DSDØETRD(ØB)	DSIDØETRD(ØB)	0.09
6" to 12"	Ø-3"	14-1/2"	1-1/2"	DSDØETRD(ØB)	DSIDØETRD(ØB)	0.11
8" to 24"	Ø-4"	15-1/2"	2"	DSDØETRD(ØB)	DSIDØETRD(ØB)	0.13
9" to 24"	Ø-5"	16-1/2"	2-1/2"	DSDØETRD(ØB)	DSIDØETRD(ØB)	0.15
10" to 24"	Ø-6"	17-1/2"	3"	DSDØETRD(ØB)	DSIDØETRD(ØB)	0.17

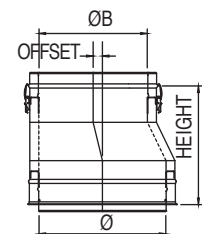

Note: DSID 9" and 24" not available.

DSD & DSID Eccentric Step Reducer

Ø	ØB Available	Height	Offset
5" to 24"	4" to 22"	8"	$(\text{Ø}-\text{ØB})/2$

Product Code DSD	Product Code DSID	K Factor
DSDØESRD(ØB)	DSIDØESRD(ØB)	$K\text{ØB} = 0.5 (1-X^2)$ $K\text{Ø} = K\text{ØB}/X^4$ where $X=\text{ØB}/\text{Ø}$

Note: DSID 9" and 24" not available.

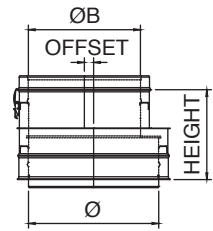

DSD Universal Muffler

Use to reduce the noise of an appliance. Install as a regular section in the evacuation line. No adapters required. Drain plug not included.

Ø	ØA	Effective Length	Product Code
6" to 14"	12" to 20"	37"	DSDØMUFFLERUB

Note: Not available for DSID.

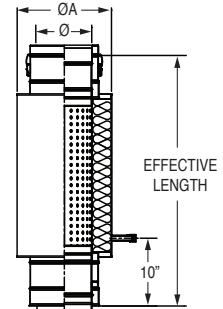

DSD & DSID Wall Thimble

Ø	Width	Product Code DSD	Product Code DSID
3" to 24"	9" to 17"	DSDØWT	DSIDØWT

Note: DSID 9" and 24" not available.
Wall penetration opening dimensions available in the installation instructions manual.

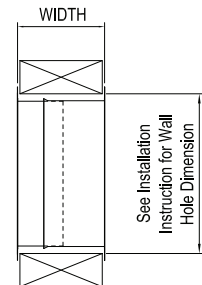
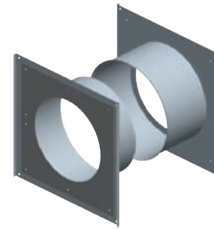

DSD & DSID Wall Thimble Insulated

Ø	Width	Product Code DSD	Product Code DSID
3" to 24"	9" to 17"	DSDØWTI	DSIDØWTI

Note: DSID 9" and 24" not available.
Wall penetration opening dimensions available in the installation instructions manual.

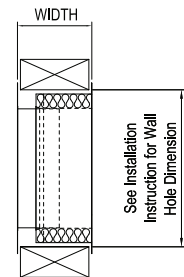
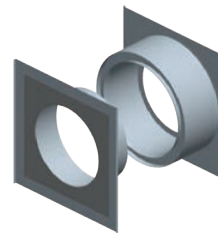

DSD & DSID Roof Thimble

Use when penetrating floor/roof levels.

Ø	Width	Product Code DSD	Product Code DSID
3" to 24"	10"	DSDØRT	DSIDØRT

Note: DSID 9" and 24" not available.
Roof/floor penetration opening dimensions available in the installation instructions manual.

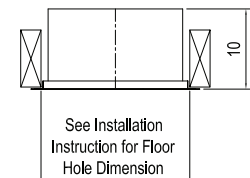
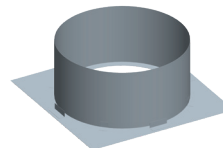

DSD & DSID Roof Thimble Insulated

Ø	Width	Product Code DSD	Product Code DSID
3" to 24"	10"	DSDØRTI	DSIDØRTI

Note: DSID 9" and 24" not available.
Roof penetration opening dimensions available in the installation instructions manual.

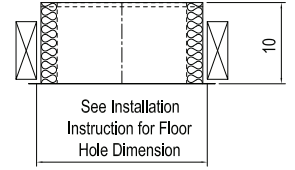
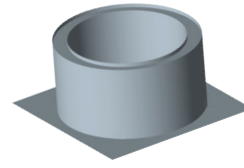

DSD & DSID Suspension Band

Ø	Product Code DSD	Product Code DSID
3" to 24"	DSDØSB	DSIDØSB

Note: DSID 9" and 24" not available.



DSD & DSID Cradle Support

Ø	Product Code DSD	Product Code DSID
3" to 24"	DSDØCS	DSIDØCS

Note: DSID 9" and 24" not available.



DSD & DSID Wall Support

Ø	A	Product Code SSD	Product Code SSID
3" to 24"	1" to 3"	DSDØWS	DSIDØWS

Note: DSID 9" and 24" not available.

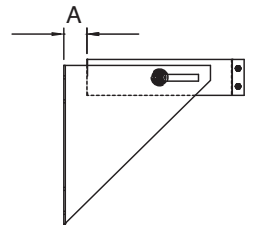
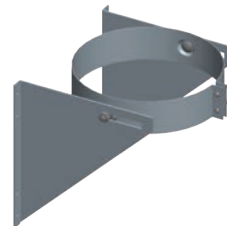

DSD Wall Support HD

Ø	A	B	C	Product Code DSD
3"	1-1/2" to 6-1/2"	8"	12"	DSD3WSHD
4"	1-1/2" to 6-1/2"	9"	12"	DSD4WSHD
5"	1-1/2" to 6-1/2"	10"	12"	DSD5WSHD
6"	1-1/2" to 6-1/2"	11"	12"	DSD6WSHD
7"	1-1/2" to 6-1/2"	12"	14"	DSD7WSHD
8"	1-1/2" to 6-1/2"	13"	14"	DSD8WSHD
9"	1-1/2" to 6-1/2"	14"	14"	DSD9WSHD
10"	1-1/2" to 6-1/2"	15"	16"	DSD10WSHD
12"	1-1/2" to 6-1/2"	17"	16"	DSD12WSHD
14"	1-1/2" to 6-1/2"	19"	22"	DSD14WSHD
16"	1-1/2" to 6-1/2"	21"	22"	DSD16WSHD
18"	1-1/2" to 6-1/2"	23"	26"	DSD18WSHD
20"	1-1/2" to 6-1/2"	25"	30"	DSD20WSHD
22"	1-1/2" to 6-1/2"	27"	30"	DSD22WSHD
24"	1-1/2" to 6-1/2"	29"	30"	DSD24WSHD

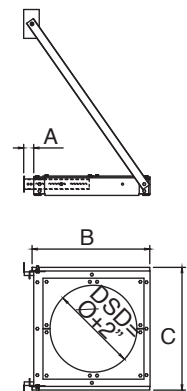

DSID Wall Support HD

Ø	A	B	C	Product Code DSID
4"	1-1/2" to 6-1/2"	11"	12"	DSID4WSHD
5"	1-1/2" to 6-1/2"	12"	14"	DSID5WSHD
6"	1-1/2" to 6-1/2"	13"	14"	DSID6WSHD
7"	1-1/2" to 6-1/2"	14"	14"	DSID7WSHD
8"	1-1/2" to 6-1/2"	15"	16"	DSID8WSHD
10"	1-1/2" to 6-1/2"	17"	16"	DSID10WSHD
12"	1-1/2" to 6-1/2"	19"	22"	DSID12WSHD
14"	1-1/2" to 6-1/2"	21"	22"	DSID14WSHD
16"	1-1/2" to 6-1/2"	23"	26"	DSID16WSHD
18"	1-1/2" to 6-1/2"	25"	30"	DSID18WSHD
20"	1-1/2" to 6-1/2"	27"	30"	DSID20WSHD
22"	1-1/2" to 6-1/2"	29"	30"	DSID22WSHD

9" and 24" not available.

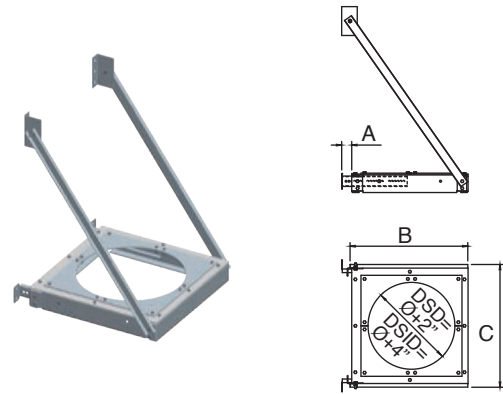

DSD & DSID Roof Support

Ø	A	B	Product Code DSD	Product Code DSID
3" to 24"	6-1/2"	7-5/8"	DSDØRSP	DSIDØRSP

Note: DSID 9" and 24" not available.

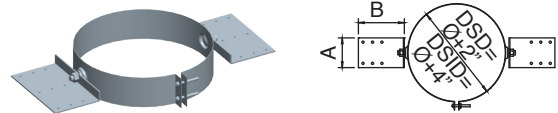

DSD & DSID Anchor Plate

Ø	A (DSD)	Product Code DSD	A (DSID)	Product Code DSID
3" to 24"	Ø+7"	DSDØA	Ø+9"	DSIDØA

Note: DSID 9" and 24" not available.

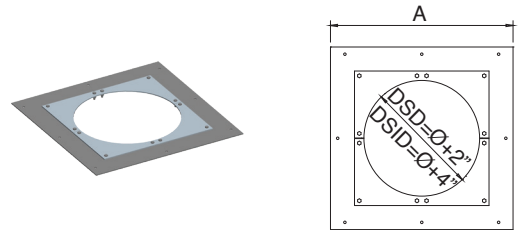

DSD & DSID Length Anchor Plate

Ø	A (DSD)	Product Code DSD	A (DSID)	Product Code DSID
3" to 24"	Ø+7"	DSDØAL	Ø+9"	DSIDØAL

Note: DSID 9" and 24" not available.

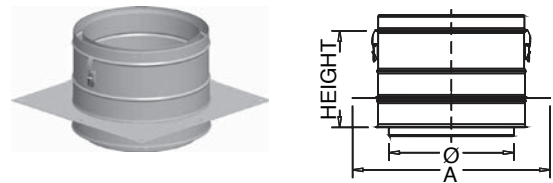

DSD & DSID Anchor Plate HD

Ø	A (DSD)	Product Code DSD	A (DSID)	Product Code DSID
3" to 24"	Ø+7"	DSDØAHD	Ø+9"	DSIDØAHD

Note: DSID 9" and 24" not available.

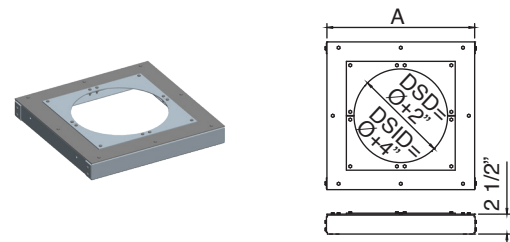

DSD & DSID Roof Brace

\emptyset	Product Code DSD	Product Code DSID
3" to 24"	DSD \emptyset RB	DSID \emptyset RB

Note: DSID 9" and 24" not available.

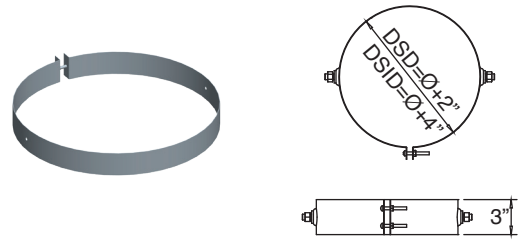

DSD & DSID Guy Wire Band

\emptyset	Product Code DSD	Product Code DSID
3" to 24"	DSD \emptyset GWB	DSID \emptyset GWB

Note: DSID 9" and 24" not available.

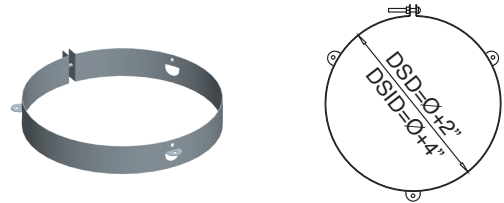

DSD & DSID Centering Band

\emptyset	Product Code DSD	Product Code DSID
3" to 24"	DSD \emptyset CB	DSID \emptyset CB

Note: DSID 9" and 24" not available.

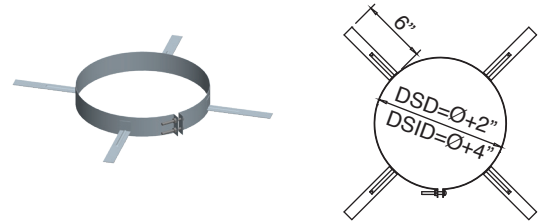

DSD & DSID Wall Guide

\emptyset	A	Product Code DSD	Product Code DSID
3" to 24"	1" to 4-1/2"	DSD \emptyset WG	DSID \emptyset WG

Note: DSID 9" and 24" not available.

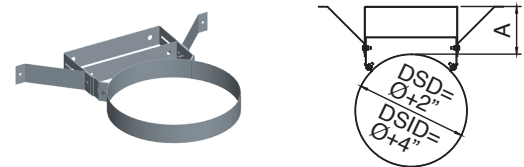

DSD & DSID Guy Support

\emptyset	Product Code DSD	Product Code DSID
3" to 24"	DSD \emptyset GS	DSID \emptyset GS

Note: DSID 9" and 24" not available.

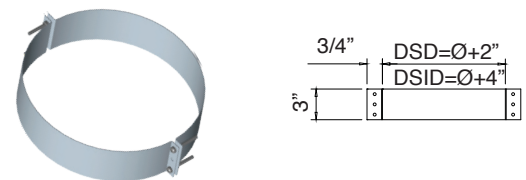

DSD & DSID Double Male Adaptor

Ø	Effective Length	Product Code DSD	Product Code DSID
3" to 24"	7-1/8"	DSDØDMA	DSIDØDMA

Note: DSID 9" and 24" not available.

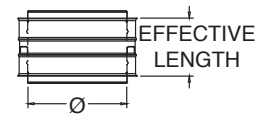
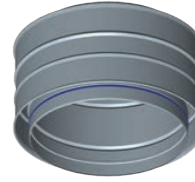

DSD & DSID Male Flange Adapter

Ø	Effective Length	Product Code DSD	Product Code DSID
3" to 24"	5-1/2"	DSDØMFA	DSIDØMFA

Includes V-bands, except in 3" and 4" diameters.

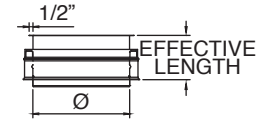
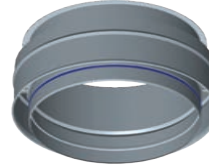

DSD & DSID Female Flange Adapter

Ø	Effective Length	Product Code DSD	Product Code DSID
3" to 24"	6-7/8"	DSDØFFA	DSIDØFFA

Note: DSID 9" and 24" not available.
Includes V-bands, except in 3" and 4" diameters.

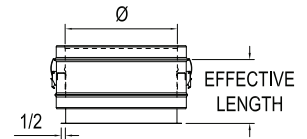
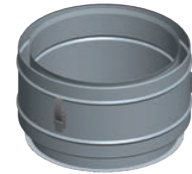

DSD & DSID to DS Adapter

Ø	Effective Length	Product Code DSD	Product Code DSID
3" to 24"	7-7/8"	DSDØDSA	DSIDØDSA

Note: DSID 9" and 24" not available.

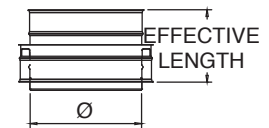
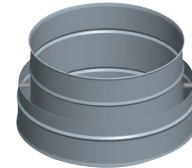

DSD to DSID Adapter

Ø	Effective Length	Product Code DSD
3" to 24"	7-5/8"	DSDØDSIDA

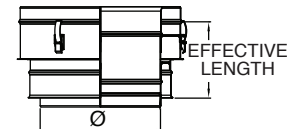
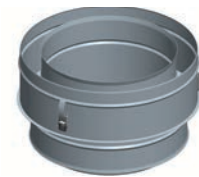

DSID to DSD Adapter

Ø	Effective Length	Product Code DSID
3" to 24"	8-1/8"	DSIDØDSDA

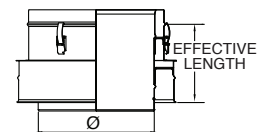
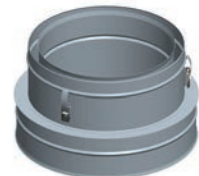

DSD Flat Flashing

Use to create a weather tight penetration where the vent passes through the roof.

\emptyset	A	Product Code DSD
3"	14"	DSD3F
4"	16"	DSD4F
5"	18"	DSD5F
6"	26"	DSD6F
7"	26"	DSD7F
8"	28"	DSD8F
9"	30"	DSD9F
10"	30"	DSD10F
12"	31"	DSD12F
14"	34"	DSD14F
16"	36"	DSD16F
18"	38"	DSD18F
20"	40"	DSD20F
22"	42"	DSD22F
24"	44"	DSD24F

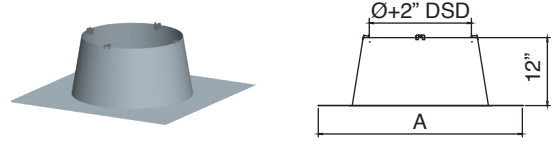
**DSID Flat Flashing**

Use to create a weather tight penetration where the vent passes through the roof.
9" and 24" not available.

\emptyset	A	Product Code DSID
4"	26"	DSID4F
5"	26"	DSID5F
6"	28"	DSID6F
7"	30"	DSID7F
8"	30"	DSID8F
10"	31"	DSID10F
12"	34"	DSID12F
14"	36"	DSID14F
16"	38"	DSID16F
18"	40"	DSID18F
20"	42"	DSID20F
22"	44"	DSID22F



DSD Adjustable Flashing

Ø	A	Height	Product Code DSD
3"	32"	12-1/2"	DSD3FA
4"	32"	12-1/2"	DSD4FA
5"	32"	12-1/2"	DSD5FA
6"	34"	12-1/2"	DSD6FA
7"	35-3/8"	12-1/2"	DSD7FA
8"	36-1/2"	12-1/2"	DSD8FA
9"	38"	12-1/2"	DSD9FA
10"	38-1/2"	12-1/2"	DSD10FA
12"	41"	12-1/2"	DSD12FA
14"	43"	12-1/2"	DSD14FA
16"	45"	12-1/2"	DSD16FA
18"	47-1/4"	12-1/2"	DSD18FA
20"	49-1/2"	12-1/2"	DSD20FA
22"	51-1/2"	12-1/2"	DSD22FA
24"	53-1/2"	12-1/2"	DSD24FA

Adjustable from 5° to 30°. Roof pitch 1/12" to 7/12".

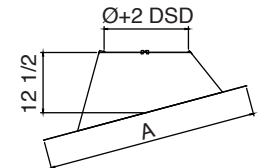
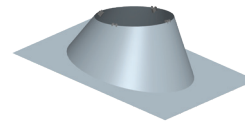

DSID Adjustable Flashing

Ø	A	Height	Product Code DSID
4"	34"	12-1/2"	DSID4FA
5"	35-3/8"	12-1/2"	DSID5FA
6"	36-1/2"	12-1/2"	DSID6FA
7"	38"	12-1/2"	DSID7FA
8"	38-1/2"	12-1/2"	DSID8FA
10"	41"	12-1/2"	DSID10FA
12"	43"	12-1/2"	DSID12FA
14"	45"	12-1/2"	DSID14FA
16"	47-1/4"	12-1/2"	DSID16FA
18"	49-1/2"	12-1/2"	DSID18FA
20"	51-1/2"	12-1/2"	DSID20FA
22"	53-1/2"	12-1/2"	DSID22FA

Adjustable from 5° to 30°. Roof pitch 1/12" to 7/12".
9" and 24" not available.

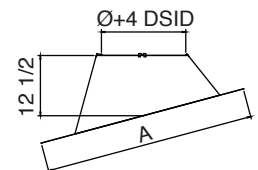
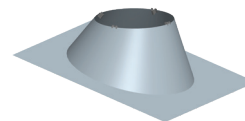

DSD & DSID Storm Collar

Use to create a weather tight seal between the pipe and flashing.

Ø	Product Code DSD	Product Code DSID
3" to 24"	DSDØSC	DSIDØSC

Note: DSID 3", 9" and 24" not available.

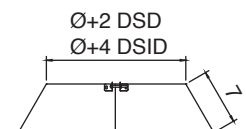
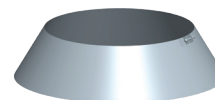

DSD & DSID Rain Cap

Use to terminate above the roof line. Not recommended in cold climate as condensate can freeze on cap.

Ø	Product Code DSD	Product Code DSD w/ Bird Screen	K Factor	Product Code DSID	Product Code w/ DSID Bird Screen
3" to 24"	DSDØRC	DSDØRCB	.50	DSIDØRC	DSIDØRCB

Note: DSID 3", 9" and 24" not available.

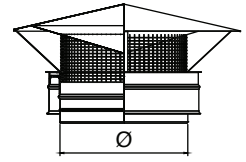
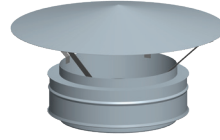

DSD & DSID Screened Termination

Use for horizontal through-the-wall terminations. Check installation instructions for restrictions on horizontal terminations, such as minimum distance from windows and doors.

Ø	Product Code DSD	Product Code DSID	K Factor
3" to 24"	DSDØST	DSIDØST	.14

Note: DSID 3", 9" and 24" not available.

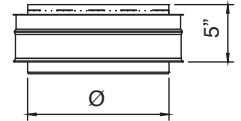
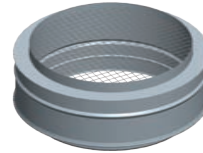

DSD & DSID 30° Screen Termination

Use for through-the-wall termination. Deters rain and other elements from entering the vent system. Check installation instructions for restrictions on horizontal terminations, such as minimum distance from windows and doors.

Ø	Product Code DSD	Product Code DSID	K Factor
3" to 24"	DSDØSTA	DSIDØSTA	.70

Note: DSID 3", 9" and 24" not available.

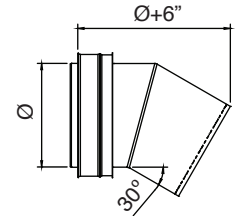
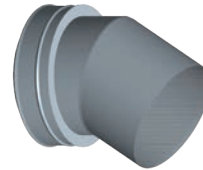

DSD 90° Screen Termination

Use for through-the-wall termination. Deters rain and other elements from entering the vent system. Check installation instructions for restrictions on horizontal terminations, such as minimum distance from windows and doors.

Ø	Product Code	K Factor
3" to 10"	DSDØST90A	.50

Note: Not available for DSID.

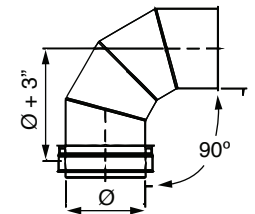
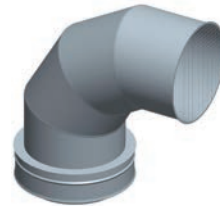

DSD & DSID Exit Cone

Use for vertical termination. Creates static back pressure to adjust harmonics. Venturi effect increases velocity of flue gases. Reduced opening provides for a smaller cross section to deter rain from entering the system.

Ø	Product Code DSD	Product Code DSID	K Factor
3" to 24"	DSDØEC	DSIDØEC	.60

Note: DSID 3", 9" and 24" not available.

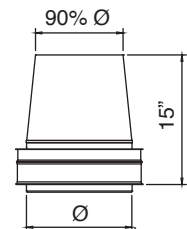

DSD & DSID Termination Tee With Screen

Use for standard and high-wind through-the-wall terminations. Check installation instructions for restrictions on horizontal terminations, such as minimum distance from windows and doors.

Ø	Product Code DSD	Product Code DSID	K Factor
3" to 24"	DSDØTT	DSIDØTT	.35

Note: DSID 3", 9" and 24" not available.

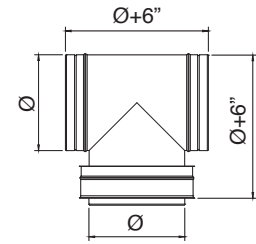
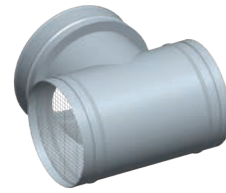

DSD & DSID Miter Cut

Ø	Product Code DSD	Product Code DSID	K Factor
3" to 24"	DSDØMC	DSIDØMC	.14

Note: DSID 3", 9" and 24" not available.

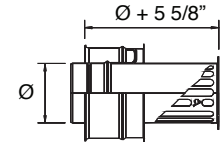
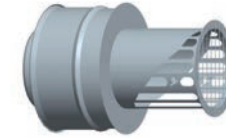

DSD & DSID Closer Termination

Ø	Product Code DSD	Product Code DSID	K Factor
3" to 24"	DSDØCT	DSIDØCT	0

Note: DSID 3", 9" and 24" not available.

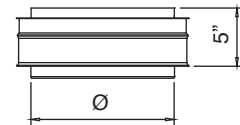
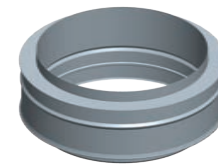

DSD & DSID OEM Termination

Ø	Product Code DSD	Product Code DSID	K Factor
3" to 24"	DSDØEMTA	DSIDØEMTA	0

Note: DSID 3", 9" and 24" not available.

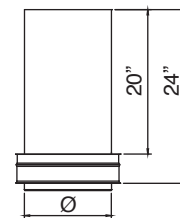
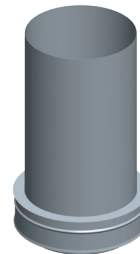

DS Lengths

Use to vent category II, III and IV appliances.

Ø	Effective Length	Product Code
3" to 24"	6-1/2"	DSØL9
3" to 24"	9-1/2"	DSØL12
3" to 24"	15-1/2"	DSØL18
3" to 24"	21-1/2"	DSØL24
3" to 24"	33-1/2"	DSØL36
5" to 9"	45-1/2"	DSØL48

Note: DSØL48 only available in 316 material.

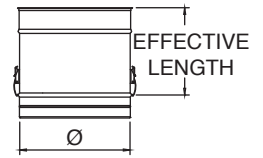

DS Adjustable Lengths

Use to add length to straight length of DS pipe. Adds 2"–14" of length. Requires at least 4" overlap for a secure connection.

Ø	Effective Length	Product Code
3" to 24"	4" to 5"	DSØAL9
3" to 24"	4" to 14"	DSØAL18

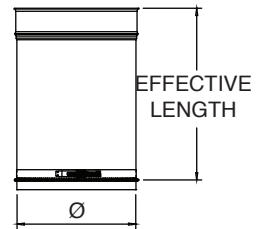

DS Test Port Lengths

Use to test for proper appliance operation without penetrating the vent wall. Easy access to perform flue gas analysis. Test port plug included.

Ø	Effective Length	Product Code
3" to 24"	6-1/2"	DSØTPL

Drain Ø4 – Ø24, 1/4 NPT, 1/2 O.D

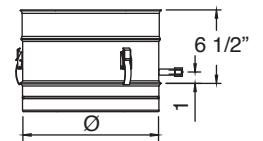
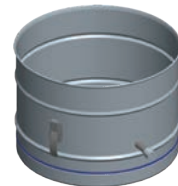

DS Drain Length

Use to properly manage corrosive condensates common with high efficiency gas appliances. For best results, install close to the appliance. Can be used horizontally, vertically, or any angle in between. Drain plug not included.

Ø	Effective Length	Product Code	K Factor
3" to 24"	6-1/2"	DSØDL	0.25

Drain Ø4 – Ø10, 1/4 NPT, 1/2 O.D
Drain Ø12 – Ø24, 1/2 NPT, 5/8 O.D

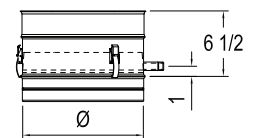
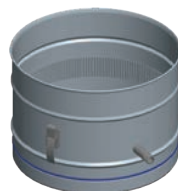

DS Damper Lengths

Ø	Effective Length	Product Code	K Factor
3" to 24"	21-3/16"	DSØDAMP	0.60 to 9999

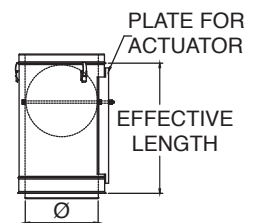

DS K&W Fixed Blade Damper Lengths

Ø	Effective Length	Product Code
6" to 18"	17-3/4"	DSØKWDAMP

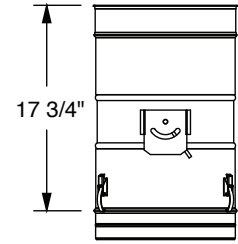

DS Motorized Damper Lengths

Ø	Effective Length	Product Code
3" to 18"	17-5/8"	DSØMOTDAMP

Note: DS 5", 7", 9", 11", 13", 15", and 17" not available.

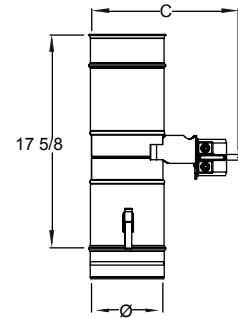

DS Telescopic Length

Telescopic lengths do not require cutting to fit dimension.

Ø	Effective Length	Product Code	
		32" Telescopic	20" Telescopic
3" to 24"	14" to 20"	DSØLAT32	DSØLAT20
3" to 24"	20" to 32"	DSØLAT32	DSØLAT20

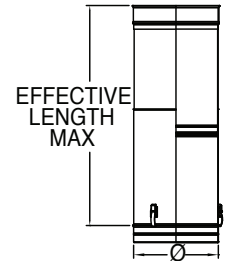

DS Damper Length Short

Ø	Effective Length	Product Code	K Factor
3" to 24"	6-3/16"	DSØDAMPS	0 to 9999

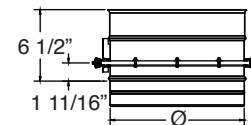
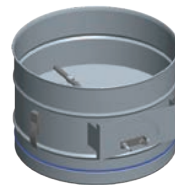

DS Vent Flow Regulator

Ø	Effective Length	Product Code	K Factor
3" to 24"	7-1/8"	DSØVFRU	0 to 9999

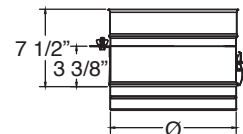
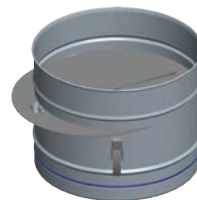

DS 2-Degree Elbow

Offsets obstructions as needed. Allows for better condensate management and less back pressure.

Ø	Offset	Rise	Product Code	K Factor
3"	1/8"	7-1/8"	DS3E2	0.04
4"	1/8"	7-1/8"	DS4E2	0.04
5" to 8"	1/8"	7-1/4"	DSØE2	0.04
9" to 12"	1/8"	7-3/8"	DSØE2	0.04
14"	1/8"	7-1/2"	DS14E2	0.03
16" to 18"	1/8"	7-5/8"	DSØE2	0.03
20" to 22"	1/8"	7-3/4"	DSØE2	0.03
24"	1/8"	7-7/8"	DS24E2	0.03

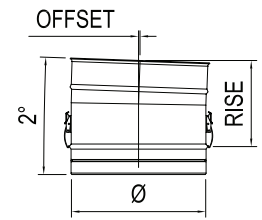
**DS 15-Degree Elbow**

Offsets obstructions as needed. Allows for better condensate management and less back pressure.

Ø	Offset	Rise	Product Code	K Factor
3"	1"	7-3/8"	DS3E15	0.32
4"	1"	7-3/4"	DS4E15	0.31
5"	1-1/8"	8-1/8"	DS5E15	0.30
6"	1-1/8"	8-1/2"	DS6E15	0.30
7"	1-1/8"	8-3/4"	DS7E15	0.29
8"	1-1/4"	9"	DS8E15	0.29
9"	1-1/4"	9-1/4"	DS9E15	0.28
10"	1-1/4"	9-1/2"	DS10E15	0.28
12"	1-3/8"	10"	DS12E15	0.27
14"	1-3/8"	10-1/2"	DS14E15	0.27
16"	1-1/2"	11"	DS16E15	0.26
18"	1-1/2"	11-1/2"	DS18E15	0.26
20"	1-5/8"	12-1/8"	DS20E15	0.26
22"	1-5/8"	12-5/8"	DS22E15	0.26
24"	1-3/4"	13-1/8"	DS24E15	0.26

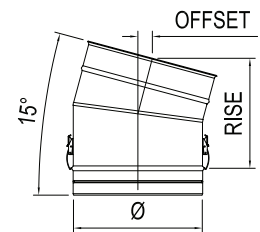
**DS 30-Degree Elbow**

Offsets obstructions as needed. Allows for better condensate management and less back pressure.

Ø	Offset	Rise	Product Code	K Factor
3"	2-1/8"	7-1/2"	DS3E30	0.62
4"	2-1/4"	8-1/2"	DS4E30	0.61
5"	2-3/8"	9"	DS5E30	0.60
6"	2-5/8"	9-1/2"	DS6E30	0.59
7"	2-3/4"	10"	DS7E30	0.58
8"	2-7/8"	10-1/2"	DS8E30	0.57
9"	3"	11"	DS9E30	0.56
10"	3-1/8"	11-1/2"	DS10E30	0.55
12"	3-3/8"	12-1/2"	DS12E30	0.54
14"	3-5/8"	13-1/2"	DS14E30	0.54
16"	3-7/8"	14-1/2"	DS16E30	0.53
18"	4-1/8"	15-1/2"	DS18E30	0.52
20"	4-1/2"	16-1/2"	DS20E30	0.52
22"	4-3/4"	17-1/2"	DS22E30	0.51
24"	5"	18-1/2"	DS24E30	0.51

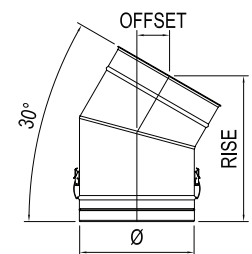

DS 45-Degree Elbow

Offsets obstructions as needed. Allows for better condensate management and less back pressure.

Ø	Offset	Rise	Product Code	K Factor
3"	3-1/4"	8"	DS3E45	0.30
4"	3-5/8"	8-3/4"	DS4E45	0.26
5"	4"	9-1/2"	DS5E45	0.22
6"	4-1/4"	10-1/2"	DS6E45	0.17
7"	4-1/2"	10-7/8"	DS7E45	0.16
8"	4-7/8"	11-5/8"	DS8E45	0.14
9"	5-1/8"	12-3/8"	DS9E45	0.13
10"	5-3/8"	13"	DS10E45	0.12
12"	6"	14-1/2"	DS12E45	0.11
14"	6-5/8"	15-7/8"	DS14E45	0.11
16"	7-1/8"	17-1/4"	DS16E45	0.10
18"	7-3/4"	18-3/4"	DS18E45	0.09
20"	8-3/8"	20-1/8"	DS20E45	0.08
22"	8-7/8"	21-1/2"	DS22E45	0.08
24"	9-1/2"	23"	DS24E45	0.08

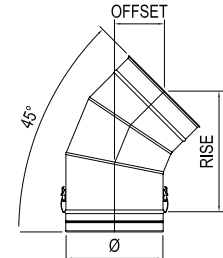

DS 88-Degree Elbow

Offsets obstructions as needed. Allows for better condensate management and less back pressure.

Ø	Offset	Rise	Product Code	K Factor
3"	6-3/8"	6-5/8"	DS3E88	0.60
4"	7-3/8"	7-5/8"	DS4E88	0.54
5"	8-3/8"	8-5/8"	DS5E88	0.48
6"	9-1/4"	9-5/8"	DS6E88	0.42
7"	10-1/4"	10-5/8"	DS7E88	0.39
8"	11-1/4"	11-5/8"	DS8E88	0.37
9"	12-1/4"	12-5/8"	DS9E88	0.34
10"	13-1/8"	13-5/8"	DS10E88	0.32
12"	15-1/8"	15-5/8"	DS12E88	0.29
14"	17"	17-5/8"	DS14E88	0.27
16"	19"	19-5/8"	DS16E88	0.25
18"	20-7/8"	21-5/8"	DS18E88	0.24
20"	22-7/8"	23-5/8"	DS20E88	0.23
22"	24-3/4"	25-5/8"	DS22E88	0.21
24"	26-5/8"	27-5/8"	DS24E88	0.20

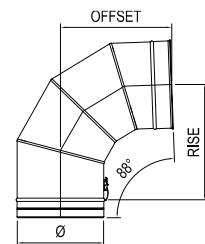
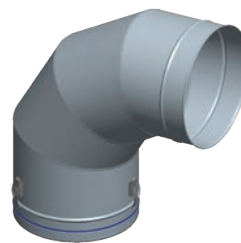

DS 90-Degree Elbow

Use to go from horizontal to vertical runs or vertical to horizontal runs. Use to turn vent 90°.

Ø	Offset	Rise	Product Code	K Factor
3"	6-3/8"	6-5/8"	DS3E90	0.60
4"	7-1/2"	7-1/2"	DS4E90	0.54
5"	8-1/2"	8-1/2"	DS5E90	0.48
6"	9-1/2"	9-1/2"	DS6E90	0.42
7"	10-1/2"	10-1/2"	DS7E90	0.39
8"	11-1/2"	11-1/2"	DS8E90	0.37
9"	12-1/2"	12-1/2"	DS9E90	0.34
10"	13-1/2"	13-1/2"	DS10E90	0.32
12"	15-1/2"	15-1/2"	DS12E90	0.29
14"	17-1/2"	17-1/2"	DS14E90	0.27
16"	19-1/2"	19-1/2"	DS16E90	0.25
18"	21-1/2"	21-1/2"	DS18E90	0.24
20"	23-1/2"	23-1/2"	DS20E90	0.23
22"	25-1/2"	25-1/2"	DS22E90	0.21
24"	27-1/2"	27-1/2"	DS24E90	0.20

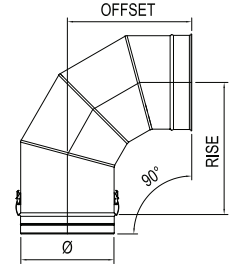
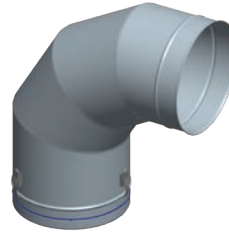
**DS Venting Tees****DS 43-Degree Tee**

Use in place of any tee for a 43° angle instead of 90°; can be used as a manifold connection to gang multiple boilers into a common vent.

Ø	Height	Offset	Rise	Product Code	K Factor
3"	13-1/4"	5-1/2"	10-3/8"	DS3T43	0.4
4"	14-1/4"	6-3/8"	11-1/8"	DS4T43	0.4
5"	15-1/4"	7-3/4"	12-7/8"	DS5T43	0.4
6"	17-1/4"	8-1/2"	13-3/4"	DS6T43	0.4
7"	18-1/4"	9-1/8"	14-3/4"	DS7T43	0.4
8"	20-1/4"	10-1/2"	16-3/8"	DS8T43	0.4
9"	21-1/4"	11-1/4"	17-1/4"	DS9T43	0.4
10"	22-1/4"	12-5/8"	19"	DS10T43	0.4
12"	25-1/4"	13-7/8"	20-3/4"	DS12T43	0.4
14"	29-1/4"	16"	23-3/8"	DS14T43	0.4
16"	32-1/4"	17-3/8"	25-1/4"	DS16T43	0.4
18"	35"	19-3/8"	27-7/8"	DS18T43	0.4
20"	38"	21-3/8"	30-3/8"	DS20T43	0.4
22"	41"	22-3/4"	32-1/4"	DS22T43	0.4
24"	44"	24-5/8"	34-5/8"	DS24T43	0.4

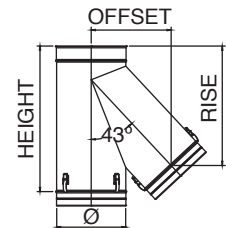

Available with smaller snout and custom height.

DS 45-Degree Tee

Use in place of any tee for a 45° angle instead of 90°; can be used as a manifold connection to gang multiple boilers into a common vent.

Ø	Height	Offset	Rise	Product Code	K Factor
3"	13-1/4"	5-1/2"	10-3/8"	DS3T45	0.4
4"	14-1/4"	6-5/8"	11"	DS4T45	0.4
5"	15-1/4"	8-1/8"	12-5/8"	DS5T45	0.4
6"	17-1/4"	8-3/4"	13-1/2"	DS6T45	0.4
7"	18-1/4"	9-1/2"	14-3/8"	DS7T45	0.4
8"	20-1/4"	10-7/8"	16"	DS8T45	0.4
9"	21-1/4"	11-5/8"	17"	DS9T45	0.4
10"	22-1/4"	13"	17-5/8"	DS10T45	0.4
12"	25-1/4"	14-1/2"	20-3/8"	DS12T45	0.4
14"	29-1/4"	15-7/8"	22-1/4"	DS14T45	0.4
16"	32-1/4"	18-1/8"	24-7/8"	DS16T45	0.4
18"	35"	20-1/4"	27-1/2"	DS18T45	0.4
20"	38"	22-1/4"	29-7/8"	DS20T45	0.4
22"	41"	23-5/8"	31-5/8"	DS22T45	0.4
24"	44"	25-1/2"	34"	DS24T45	0.4

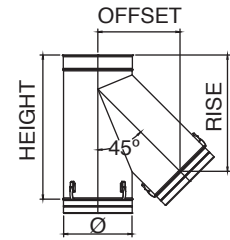

Available with smaller snout and custom height.

DS 88-Degree Tee

Use for an 88° offset, or to combine connections from two or more appliances into a common vent. Can also use as a condensate management point when used in conjunction with drain fitting. All Standard Tees are completely welded.

Ø	Height	Offset	Rise	Product Code	K Factor
3"	10-1/4"	5-3/8"	5-1/4"	DS3T88	1.21
4"	11-1/4"	6-3/8"	5-5/8"	DS4T88	1.21
5"	12-1/4"	7-3/8"	6-1/4"	DS5T88	1.21
6"	13-1/4"	7-3/8"	6-5/8"	DS6T88	1.21
7"	14-1/4"	8-3/8"	7-1/4"	DS7T88	1.21
8"	15-1/4"	8-3/8"	7-5/8"	DS8T88	1.21
9"	16-1/4"	9-3/8"	8-1/4"	DS9T88	1.21
10"	17-1/4"	9-3/8"	8-5/8"	DS10T88	1.21
12"	19-1/4"	10-3/8"	9-3/4"	DS12T88	1.21
14"	21-1/4"	11-3/8"	10-3/4"	DS14T88	1.21
16"	23-1/4"	12-3/8"	11-3/4"	DS16T88	1.21
18"	25-1/4"	13-3/8"	12-3/4"	DS18T88	1.21
20"	27-1/4"	14-3/8"	13-3/4"	DS20T88	1.21
22"	29-1/4"	15-3/8"	14-3/4"	DS22T88	1.21
24"	31-1/4"	16-3/8"	15-3/4"	DS24T88	1.21

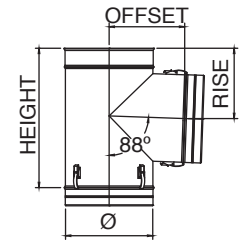

Available with smaller snout and custom height.

DS 90-Degree Tee

Use for a 90° offset, or to combine connections from two or more appliances into a common vent. Can also use as a condensate management point when used in conjunction with drain fitting. All Standard Tees are completely welded.

Ø	Height	Offset	Rise	Product Code	K Factor
3"	10-1/4"	5-3/8"	5-1/4"	DS3T90	1.21
4"	11-1/4"	6-3/8"	5-1/2"	DS4T90	1.21
5"	12-1/4"	7-3/8"	6"	DS5T90	1.21
6"	13-1/4"	7-3/8"	6-1/2"	DS6T90	1.21
7"	14-1/4"	8-3/8"	7"	DS7T90	1.21
8"	15-1/4"	8-3/8"	7-1/2"	DS8T90	1.21
9"	16-1/4"	9-3/8"	8"	DS9T90	1.21
10"	17-1/4"	9-3/8"	8-1/2"	DS10T90	1.21
12"	19-1/4"	10-3/8"	9-1/2"	DS12T90	1.21
14"	21-1/4"	11-3/8"	10-1/2"	DS14T90	1.21
16"	23-1/4"	12-3/8"	11-1/2"	DS16T90	1.21
18"	25-1/4"	13-3/8"	12-1/2"	DS18T90	1.21
20"	27-1/4"	14-3/8"	13-1/2"	DS20T90	1.21
22"	29-1/4"	15-3/8"	14-1/2"	DS22T90	1.21
24"	31-1/4"	16-3/8"	15-1/2"	DS24T90	1.21

Available with smaller snout and custom height.
Available with removeable branch (Not Listed). CODE: DSØT90BRU

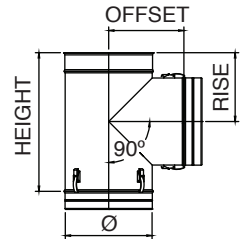
**DS 90-Degree Tee Y**

Ø	Offset	Rise	Product Code	K Factor
3"	4-1/2"	8-1/2"	DS3TY90	0.6
4"	4-1/2"	8-1/2"	DS4TY90	0.6
5"	5-1/4"	10-1/8"	DS5TY90	0.6
6"	5-1/4"	10-1/8"	DS6TY90	0.6
7"	6"	10-7/8"	DS7TY90	0.6
8"	6"	10-7/8"	DS8TY90	0.6
9"	6-5/8"	12-5/8"	DS9TY90	0.6
10"	6-5/8"	12-5/8"	DS10TY90	0.6
12"	7-3/8"	13-1/4"	DS12TY90	0.6
14"	8-1/8"	15"	DS14TY90	0.6
16"	8-3/4"	16-3/4"	DS16TY90	0.6
18"	9-1/2"	17-3/8"	DS18TY90	0.6
20"	10-1/4"	18-1/8"	DS20TY90	0.6
22"	10-7/8"	18-7/8"	DS22TY90	0.6
24"	11-5/8"	20-1/2"	DS24TY90	0.6

Available with smaller snout and custom height.

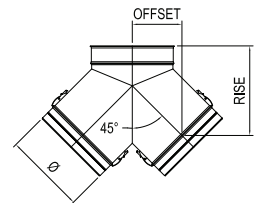
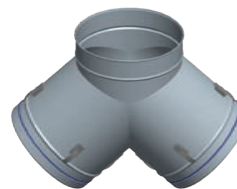

DS Lateral Tee

Use to transition from horizontal to vertical with improved flue gas flow.

Ø	Height	Offset	Rise	Product Code	K Factor
3"	9-1/8"	8-1/2"	7-3/4"	DS3BT	0.55
4"	10-1/8"	9-1/4"	8-7/8"	DS4BT	0.55
5"	12-1/8"	10-1/2"	10"	DS5BT	0.55
6"	13-1/8"	11-3/4"	11-1/8"	DS6BT	0.55
7"	15-1/8"	13"	12-1/4"	DS7BT	0.55
8"	16-1/8"	14-1/4"	13-3/8"	DS8BT	0.55
9"	18-1/8"	12-1/2"	12-1/2"	DS9BT	0.55
10"	19-1/8"	13-3/8"	13-3/8"	DS10BT	0.55
12"	22-1/8"	15-1/4"	15-1/4"	DS12BT	0.55
14"	25-1/8"	17"	17"	DS14BT	0.55
16"	28-1/8"	18-7/8"	18-7/8"	DS16BT	0.55
18"	30-7/8"	20-3/4"	20-1/2"	DS18BT	0.55
20"	33-7/8"	22-1/2"	22-1/2"	DS20BT	0.55
22"	36-7/8"	24-3/8"	24-3/8"	DS22BT	0.55
24"	39-7/8"	26-1/8"	26-1/4"	DS24BT	0.55

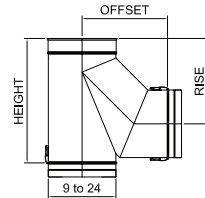
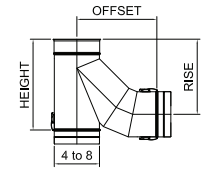

Available with smaller snout and custom height.

DS Lateral Tee 88-Degree

Use to transition from horizontal to vertical with improved flue gas flow.

Ø	Height	Offset	Rise	Product Code	K Factor
3"	10-1/8"	8-1/2"	8-1/2"	DS3BT88	0.55
4"	11-1/8"	9-1/4"	9-1/4"	DS4BT88	0.55
5"	12-1/8"	10-1/2"	10-1/2"	DS5BT88	0.55
6"	14-1/8"	11-3/4"	11-3/4"	DS6BT88	0.55
7"	16-1/8"	13"	13"	DS7BT88	0.55
8"	17-1/8"	14-1/4"	14-1/8"	DS8BT88	0.55
9"	19-1/8"	12-5/8"	13-1/4"	DS9BT88	0.55
10"	20-1/8"	13-1/2"	14-1/4"	DS10BT88	0.55
12"	23-1/8"	15-3/8"	16-1/8"	DS12BT88	0.55
14"	26-1/8"	17-3/8"	18-1/8"	DS14BT88	0.55
16"	29-1/8"	19-1/8"	20-1/8"	DS16BT88	0.55
18"	31-7/8"	21"	22"	DS18BT88	0.55
20"	34-7/8"	22-7/8"	24"	DS20BT88	0.55
22"	37-7/8"	24-3/4"	26"	DS22BT88	0.55
24"	40-7/8"	26-5/8"	28"	DS24BT88	0.55

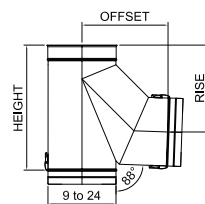
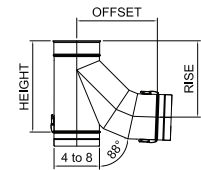

Available with smaller snout and custom height.

DS Barometric Tee

Ø	Height	Offset	Rise	Product Code	K Factor
3"	10-1/4"	5"	5"	DS3BMT	0.2
4"	11-1/4"	5"	5-1/2"	DS4BMT	0.2
5"	12-1/4"	5"	6"	DS5BMT	0.2
6"	13-1/4"	6"	6-1/2"	DS6BMT	0.2
7"	14-1/4"	7"	7"	DS7BMT	0.2
8"	15-1/4"	8"	7-1/2"	DS8BMT	0.2
9"	16-1/4"	9"	8"	DS9BMT	0.2
10"	17-1/4"	10"	8-1/2"	DS10BMT	0.2
12"	19-1/4"	12"	9-1/2"	DS12BMT	0.2
14"	21-1/4"	14"	10-1/2"	DS14BMT	0.2
16"	23-1/4"	16"	11-1/2"	DS16BMT	0.2
18"	25-1/4"	18"	12-1/2"	DS18BMT	0.2
20"	27-1/4"	20"	13-1/2"	DS20BMT	0.2
22"	29-1/4"	22"	14-1/2"	DS22BMT	0.2
24"	31-1/4"	24"	15-1/2"	DS24BMT	0.2

Available with smaller snout and custom height.

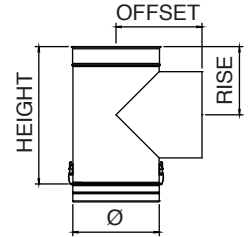

DS Tee Cap

Use to cap Standard Tee, Branch Tee or Boot Tee. Remove Tee Cap to inspect the system; clean out debris or collected condensate.

Ø	Height	Product Code
3" to 24"	3-1/2"	DSØTC

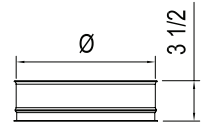
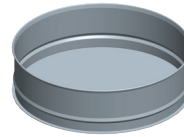

DS Drain Tee Cap

Use instead of Tee Cap to manage condensates at the bottom of a vertical run. Drain plug not included.

Ø	Height	Product Code
3" to 24"	3-1/2"	DSØDTC

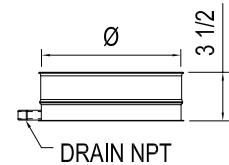

Drain Ø4 – Ø10, 1/4 NPT, 1/2 O.D.
Drain Ø12 – Ø24, 3/8 NPT, 5/8 O.D

DS Barometric Tee Cap

Ø	Height	Product Code
3" to 24"	3-1/2"	DSØBMTTC

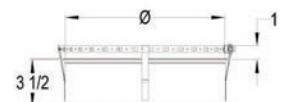

DS Tapered Inserter

Use to increase vent diameter. Creates a smooth transition for an undistruptive flow. Available in custom size combinations.

Ø	ØB Available	Height	Product Code	K Factor
3" to 9"	Ø+1"	11-7/8"	DSØTIN(ØB)	0.05
3" to 22"	Ø+2"	12-7/8"	DSØTIN(ØB)	0.10
3" to 9"	Ø+3"	13-7/8"	DSØTIN(ØB)	0.15
3" to 20"	Ø+4"	14-7/8"	DSØTIN(ØB)	0.20
3" to 7"	Ø+5"	15-7/8"	DSØTIN(ØB)	0.25
3" to 18"	Ø+6"	16-7/8"	DSØTIN(ØB)	0.30

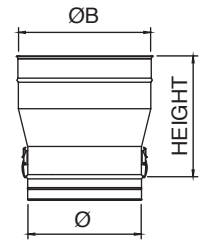

DS Step Inserter

Use to increase vent diameter when space constraints are an issue. Available in custom size combinations.

Ø	ØB Available	Height	Product Code	K Factor
3" to 22"	5" to 24"	10"	DSØSIN(ØB)	$KØ = (1-X^2)^2$ $KØB = KØ/X^4$ where $X = Ø/ØB$

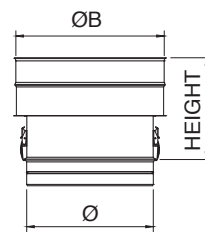

DS Eccentric Tapered Inserter

Use to transition to a larger diameter pipe. Prevents condensate puddling when used on horizontal runs. Aids in reducing formation of condensates. Available in custom size combinations.

Ø	ØB Available	Height	Offset	Product Code	K Factor
3" to 9"	Ø+1"	12-1/4"	1/2"	DSØETIN(ØB)	0.05
3" to 22"	Ø+2"	13-1/4"	1"	DSØETIN(ØB)	0.10
3" to 9"	Ø+3"	14-1/4"	1-1/2"	DSØETIN(ØB)	0.15
3" to 20"	Ø+4"	15-1/4"	2"	DSØETIN(ØB)	0.20
3" to 7"	Ø+5"	16-1/4"	2-1/2"	DSØETIN(ØB)	0.25
3" to 18"	Ø+6"	17-1/4"	3"	DSØETIN(ØB)	0.30

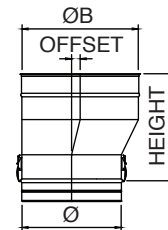

DS Eccentric Step Inserter

Ø	ØB Available	Height	Offset	Product Code	K Factor
3" to 22"	5" to 24"	10"	$(ØB-ØA)/2$ "	DSØESIN(ØB)	$KØ = (1-X^2)^2$ $KØB = KØ/X^4$ where $X = Ø/ØB$

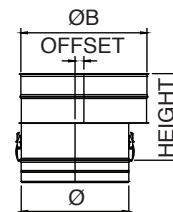

DS Tapered Reducer

Use to reduce vent diameter. Creates a smooth transition for an undrruptive flow. Available in custom size combinations.

Ø	ØB Available	Height	Product Code	K Factor
5" to 10"	Ø+1"	11-7/8"	DSØTRD(ØB)	0.07
6" to 24"	Ø+2"	12-7/8"	DSØTRD(ØB)	0.09
6" to 12"	Ø+3"	13-7/8"	DSØTRD(ØB)	0.11
8" to 24"	Ø+4"	14-7/8"	DSØTRD(ØB)	0.13
9" to 24"	Ø+5"	15-7/8"	DSØTRD(ØB)	0.15
10" to 24"	Ø+6"	16-7/8"	DSØTRD(ØB)	0.17

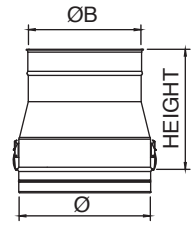

DS Step Reducer

Use to reduce vent diameter when space constraints are an issue. Available in custom size combinations.

Ø	ØB Available	Height	Product Code	K Factor
5" to 24"	4" to 22"	10"	DSØSRD(ØB)	$KØB = 0.5(1-X^2)^2$ $KØ = KØB/X^4$ where $X = ØB/Ø$

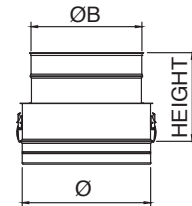

DS Eccentric Tapered Reducer

Ø	ØB Available	Height	Offset	Product Code	K Factor
5" to 10"	Ø+1"	12-1/4"	1/2"	DSØETRD(ØB)	0.07
6" to 24"	Ø+2"	13-1/4"	1"	DSØETRD(ØB)	0.09
6" to 12"	Ø+3"	14-1/4"	1-1/2"	DSØETRD(ØB)	0.11
8" to 24"	Ø+4"	15-1/4"	2"	DSØETRD(ØB)	0.13
9" to 24"	Ø+5"	16-1/4"	2-1/2"	DSØETRD(ØB)	0.15
10" to 24"	Ø+6"	17-1/4"	3"	DSØETRD(ØB)	0.17

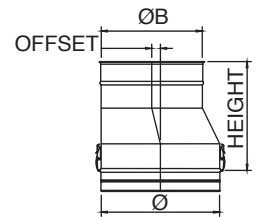

DS Eccentric Step Reducer

Ø	ØB Available	Height	Offset	Product Code	K Factor
5" to 10"	4" to 22"	10"	(ØA-ØB)/2"	DSØESRD(ØB)	$KØB = 0.5(1-X^2)^2$ $KØ = KØB/X^4$ where $X = ØB/Ø$

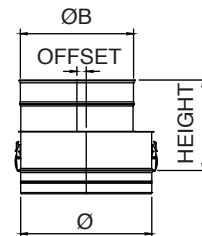

DS Wall Thimble

Use for through-the-wall installation. Fits between standard wall studs.

Ø	Height	Product Code
3" to 24"	9" to 17"	DSØWT

Wall penetration opening dimensions available in the installation instructions manual.

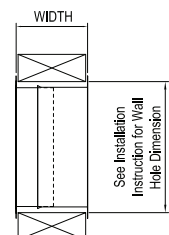
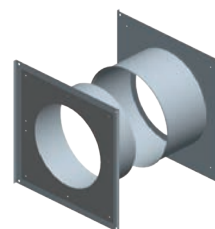

DS Wall Thimble Insulated

Ø	Height	Product Code
3" to 24"	9" to 17"	DSØWTI

Wall penetration opening dimensions available in the installation instructions manual.

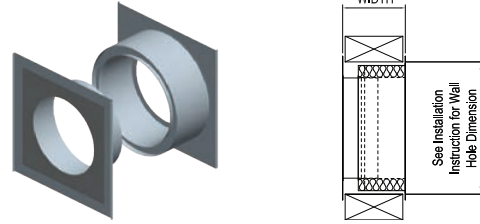

DS Roof Thimble

Ø	Height	Product Code
3" to 24"	10"	DSØRT

Roof/floor penetration opening dimensions available in the installation instructions manual.

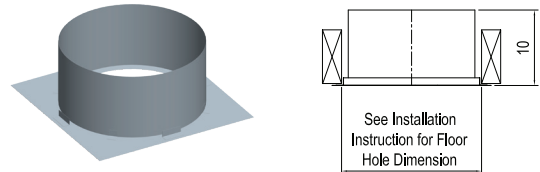

DS Roof Thimble Insulated

Ø	Height	Product Code
3" to 24"	10"	DSØRTI

Roof/floor penetration opening dimensions available in the installation instructions manual.

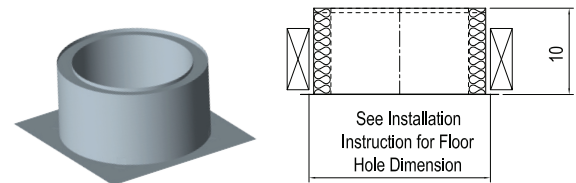

DS Suspension Band

Ø	Product Code
3" to 24"	DSØSB

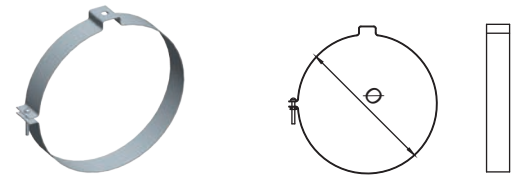

DS Cradle Support

Ø	Product Code
3" to 24"	DSØCS

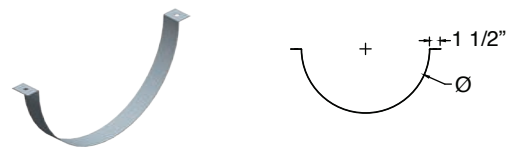

DS Wall Support

Use to support vent pipe or tee sections. Provides proper clearance to combustibles.

Ø	Height	Product Code
3" to 12"	2" to 5"	DSØWS
14" to 24"	4" to 7"	DSØWS

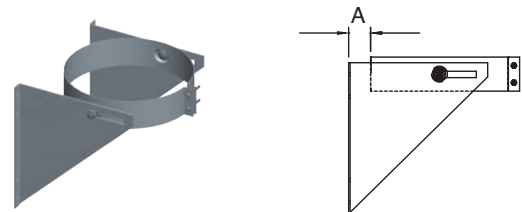

DS Wall Support HD

Ø	A	B	C	Product Code
3"	2" to 7"	7"	8"	DS3WSHD
4"	2" to 7"	7"	8"	DS4WSHD
5"	2" to 7"	9"	9"	DS5WSHD
6"	2" to 7"	12"	10"	DS6WSHD
7"	2" to 7"	12"	11"	DS7WSHD
8"	2" to 7"	12"	12"	DS8WSHD
9"	2" to 7"	14"	13"	DS9WSHD
10"	2" to 7"	14"	14"	DS10WSHD
12"	2" to 7"	16"	16"	DS12WSHD
14"	4" to 9"	22"	20"	DS14WSHD
16"	4" to 9"	22"	22"	DS16WSHD
18"	4" to 9"	26"	24"	DS18WSHD
20"	4" to 9"	26"	26"	DS20WSHD
22"	4" to 9"	30"	28"	DS22WSHD
24"	4" to 9"	30"	30"	DS24WSHD

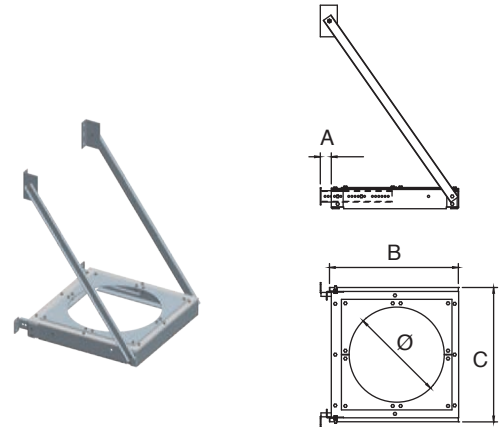

DS Roof Support

Ø	A	B	Product Code
3" to 12"	6-1/2"	7-5/8"	DSØRS
14" to 24"	22" to 32"		DSØRS

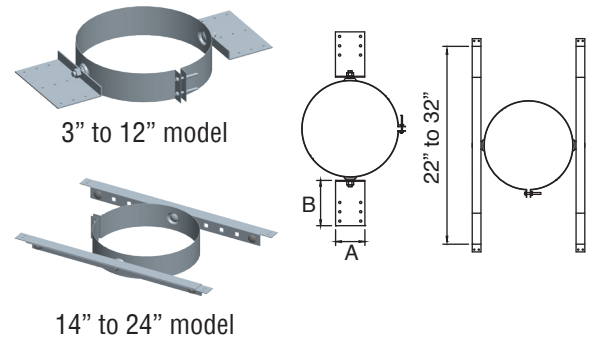

DS Anchor Plate

Use when penetrating floor levels.

Ø	A	Product Code
3" to 12"	Ø+7"	DSØA
14" to 24"	Ø+11"	DSØA

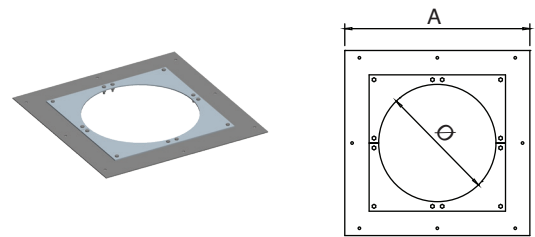

DS Length Anchor Plate

Ø	A	Product Code
3" to 12"	Ø+7"	DSØAL
14" to 24"	Ø+11"	DSØAL

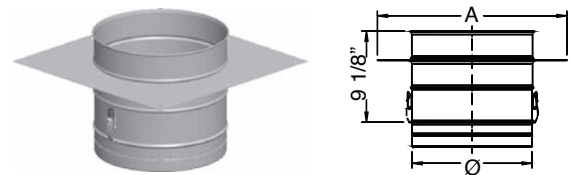

DS Anchor Plate HD

Use when penetrating floor levels.

\emptyset	A	Product Code
3" to 12"	$\emptyset+7"$	DS \emptyset AHD
14" to 24"	$\emptyset+11"$	DS \emptyset AHD

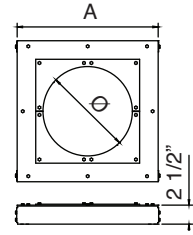
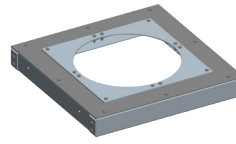

DS Roof Brace

\emptyset	Product Code
3" to 24"	DS \emptyset RB

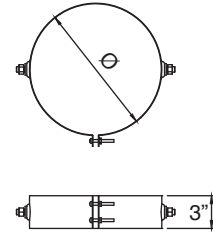

DS Guy Wire Band

\emptyset	Product Code
3" to 24"	DS \emptyset GWB

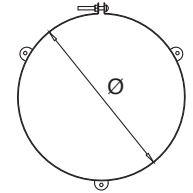

DS Centering Band

\emptyset	Product Code
3" to 24"	DS \emptyset CB

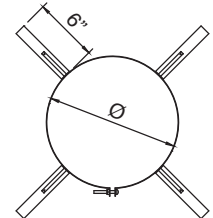
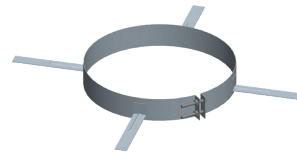

DS Wall Guide

\emptyset	A	Product Code
3" to 24"	2" to 5-1/2"	DS \emptyset WG
14" to 24"	4" to 7-1/2"	DS \emptyset WG

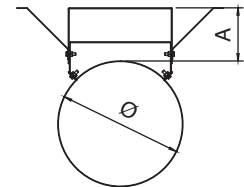

DS Guy Support

Ø	Product Code
3" to 24"	DSØGS

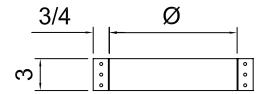

DS Double Male Adapter

Ø	Effective Length	Product Code
3" to 24"	3-7/8"	DSØDMA

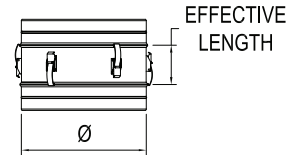
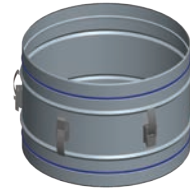

DS Male Flange Adapter

Ø	Effective Length	Product Code
3" to 24"	4-7/8"	DSØMFA

Includes V-bands, except in 3" and 4" diameters.

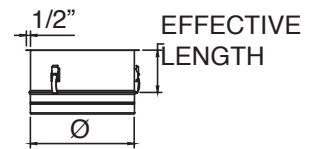
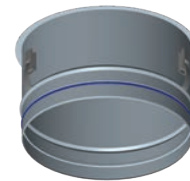

DS Female Flange Adapter

Ø	Effective Length	Product Code
3" to 24"	4-1/4"	DSØFFA

Includes V-bands, except in 3" and 4" diameters.

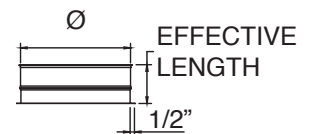

DS to DSD/DSID Adapter

Ø	Effective Length	Product Code	Product Code
3" to 24"	7-7/8"	DSØDSDA	DSØDSIDA

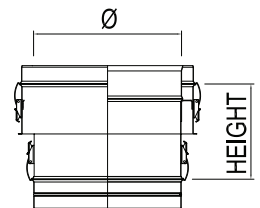

DS Flat Flashing

Ø	A	Product Code
3" to 6"	16"	DSØ4F
7"	18"	DS7F
8" to 9"	26"	DSØF
10"	28"	DS10F
12"	30"	DS12F
14"	31"	DS14F
16"	34"	DS16F
18"	36"	DS18F
20"	38"	DS20F
22"	40"	DS22F
24"	42"	DS24F

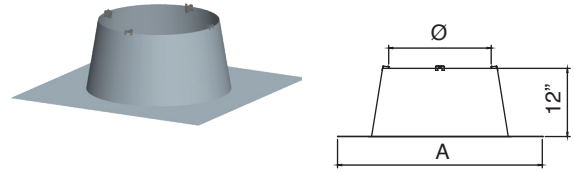

DS Adjustable Flashing

Ø	A	Height	Product Code
3" to 5"	30"	12-1/2"	DSØFA
6" to 7"	32"	12-1/2"	DS6FA
8"	34"	12-1/2"	DS8FA
9"	35-3/8"	12-1/2"	DS9FA
10"	36-1/2"	12-1/2"	DS10FA
12"	38-1/2"	12-1/2"	DS12FA
14"	41"	12-1/2"	DS14FA
16"	43"	12-1/2"	DS16FA
18"	45"	12-1/2"	DS18FA
20"	47-1/4"	12-1/2"	DS20FA
22"	49-1/2"	12-1/2"	DS22FA
24"	51-1/2"	12-1/2"	DS24FA

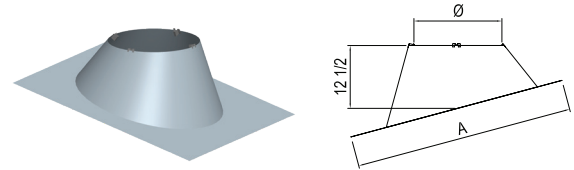

Adjustable from 5° to 30°.
Roof pitch 1/12" to 7/12".

DS Storm Collar

Ø	Effective Length	Product Code
3" to 24"	6-1/4"	DSØSC



DS Rain Cap

Use to terminate above the roof line. Not recommended in cold climate as condensate can freeze on cap.

Ø	Product Code	Product Code with Bird Screen	K Factor
3" to 24"	DSØRC	DSØRCB	.50

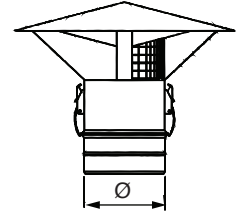
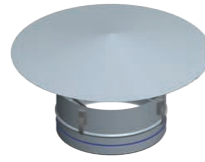

DS Screened Termination

Use for horizontal through-the-wall terminations. Check installation instructions for restrictions on horizontal terminations, such as minimum distance from windows and doors.

Ø	Product Code	K Factor
3" to 24"	DSØST	.14

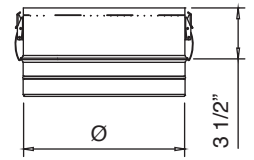
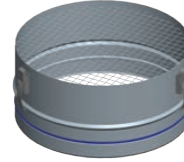

DS 30° Screen Termination

Use for through-the-wall termination. Deters rain and other elements from entering the vent system. Check installation instructions for restrictions on horizontal terminations, such as minimum distance from windows and doors.

Ø	Product Code	K Factor
3" to 24"	DSØSTA	.70

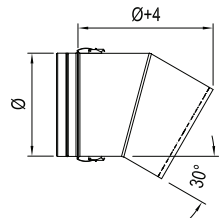
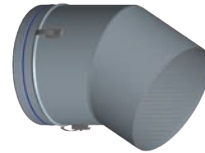

DS 90° Screen Termination

Use for through-the-wall termination. Deters rain and other elements from entering the vent system. Check installation instructions for restrictions on horizontal terminations, such as minimum distance from windows and doors.

Ø	Product Code	K Factor
3" to 10"	DSØST90A	.50

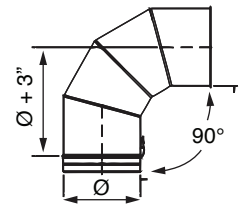

DS Exit Cone

Use for vertical termination. Creates static back pressure to adjust harmonics. Venturi effect increases velocity of flue gases. Reduced opening provides for a smaller cross section to deter rain from entering the system.

Ø	Product Code	K Factor
3" to 24"	DSØEC	.60

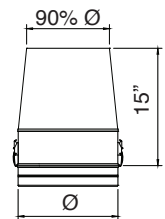

DS Termination Tee With Screen

Use for standard and high-wind through-the-wall terminations. Check installation instructions for restrictions on horizontal terminations, such as minimum distance from windows and doors.

Ø	Product Code	K Factor
3" to 24"	DSØTT	.35

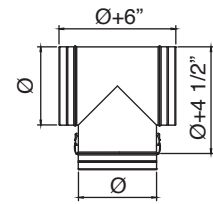

DS Miter Cut

Ø	Product Code	K Factor
3" to 24"	DSØMC	.14

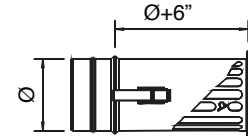

Dura Seal Flex

Use to vent Category II,III and IV gas burning appliances. Listed to UL 1738. Can only be used in vertical or near vertical runs.

Ø	Length	Product Code
3" to 8"	20'	DSØFLEX-20
3" to 8"	25'	DSØFLEX-25
3" to 8"	30'	DSØFLEX-30
3" to 8"	35'	DSØFLEX-35
3" to 8"	125'	DSØFLEX-125

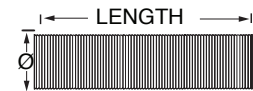

Adapter DS to Flex

Ø	Length	Product Code
3" to 12"	5 3/8'	DSØAMF

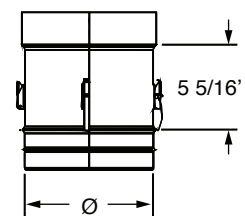

Adapter DS Flex to DS

Ø	Length	Product Code
3" to 12"	7 3/4'	DSØAFF

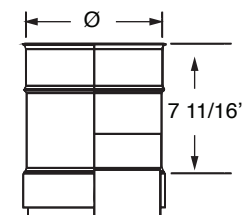

Adapter DS Flex to Flex

Ø	Length	Product Code
3" to 12"	5 3/4'	DSØAF

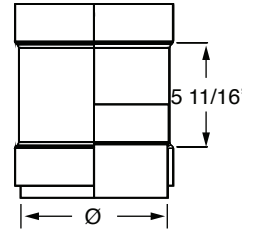

Fulton EDR 2000/3000, 4000 & 5000/6000 DS Adapter

Ø	ØB (O.D.)	Height	Offset	A	Product Code
8"	5 23/32"	9 7/16"	1 1/8"	0	DS5.7FEDR8U
8"	5 23/32"	9 7/16"	1 1/8"	0	DS5.7FEDR8B
12"	9 5/8"	9 11/16"	1 3/16"	3	DS12FEDRU
12"	9 5/8"	9 11/16"	1 3/16"	3	DS12FEDRB
14"	9 5/8"	9 11/16"	2 3/16"	3	DS14FEDRU
14"	9 5/8"	9 11/16"	2 3/16"	3	DS14FEDRB

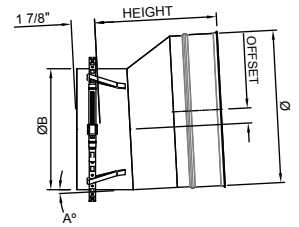

Fulton EDR 2000/3000, 4000 & 5000/6000 DSD Adapter

Ø	ØB (O.D.)	Height	Offset	A	Product Code
8"	5 23/32"	9 3/16"	1 1/8"	0	DSD5.7FEDR8UK
8"	5 23/32"	9 3/16"	1 1/8"	0	DSD5.7FEDR8BK
12"	9 5/8"	9 7/16"	1 3/16"	3	DSD12FEDRUK
12"	9 5/8"	9 7/16"	1 3/16"	3	DSD12FEDRBK
14"	9 5/8"	9 7/16"	2 3/16"	3	DSD14FEDRUK
14"	9 5/8"	9 7/16"	2 3/16"	3	DSD14FEDRBK

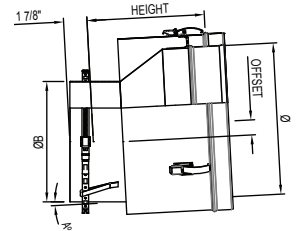



BUILD FOR THE FUTURE

Customer Service and Support:

Airmate (USA).....	800.992.8368
Airmate (CAN).....	888.735.5475
Ameriflow.....	800.252.8467
Amerivent (Retail).....	800.252.8467
Amerivent (Wholesale).....	800.423.4270
Amerivent (Support).....	800.748.0392
AMPCO (USA).....	800.669.3269
AMPCO (CAN).....	888.735.5475
Duravent.....	800.835.4429
Hart & Cooley.....	800.433.6341
Hart & Cooley (Support).....	800.748.0392
Heatfab (USA).....	800.772.0739
Heatfab (CAN).....	800.848.2149
Lima.....	800.423.4270
Milcor.....	800.774.5240
Portals Plus.....	800.774.5240
RPS.....	800.624.8642
Security Chimney (USA).....	800.361.4909
Security Chimney (CAN).....	800.667.3387
Selkirk (USA).....	800.848.2149
Selkirk (CAN).....	888.735.5475
Selkirk (Support).....	800.748.0392

Manufacturing & Distribution Centers:

CANADA	
Nobel, ON	Manufacturing
Laval, QC	Manufacturing
Prescott, ON	Distribution
USA	
Grand Rapids, MI	Center of Excellence
Dallas, TX	Distribution
Englewood, OH	Distribution
Huntsville, AL	Manufacturing & Distribution
Mira Loma, CA	Distribution
Nampa, ID	Manufacturing & Distribution
Turner Falls, MA	Manufacturing & Distribution
Vacaville, CA	Manufacturing
MEXICO	
Ojinaga, MX	Manufacturing
Mexicali, MX	Manufacturing

Corporate Headquarters:

Duravent Group
 28 W. Adams, Suite 1810
 Detroit, MI 48226
 Tel: 800.835.4429
 Email: info@duraventgroup.com
www.duraventgroup.com

duravent™

duravent™
GROUP

BUILD FOR THE FUTURE

www.duraventgroup.com

