

duravent[™]

FasNSeal[®]

For use with natural gas or propane
Categories II, III, and IV appliances or
Canada's Type BH Gas Vent Systems



AV

FASNSEAL 80/90

Change to High Efficiency? Utilize Your Existing Common Vent!

LISTINGS

Duravent's FNS 80/90 Combination Cat I and Cat IV gas vent system is designed and UL listed for use with approved Duravent special gas vent components only! Listed to applicable portions of ULC S636/UL1777, and UL441.

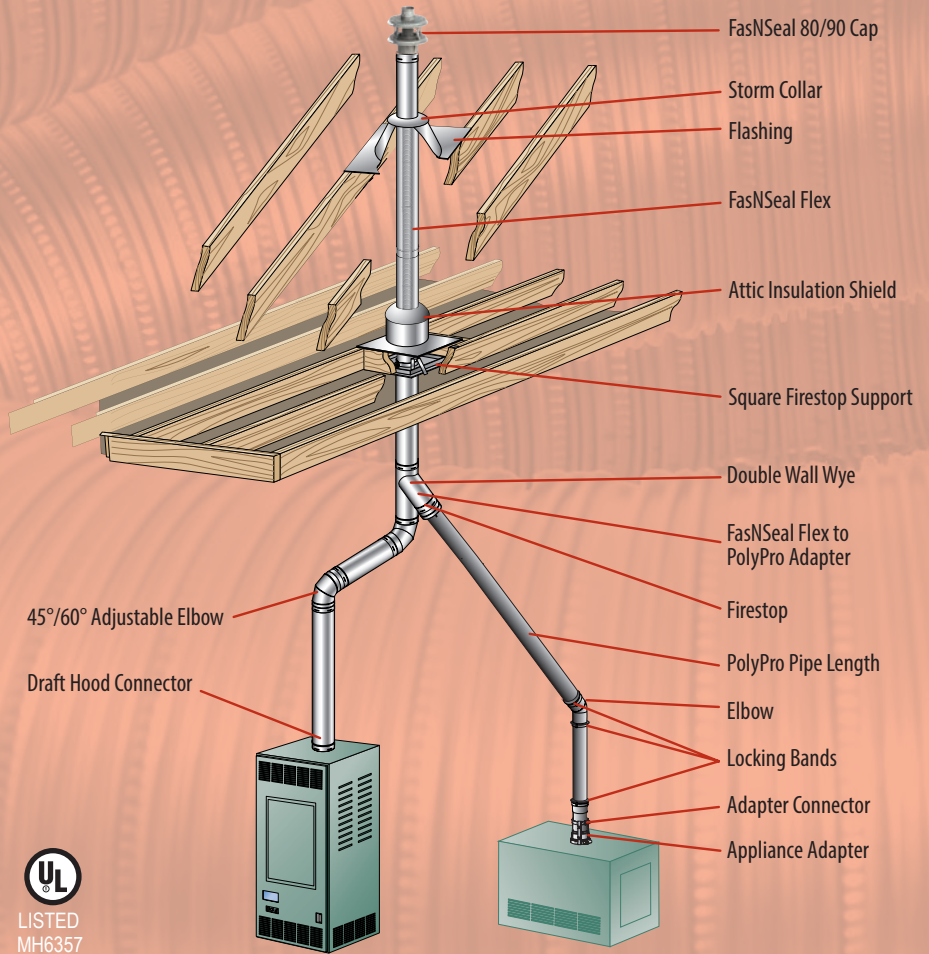

FasNSeal 80/90 Feature	Benefit
Available in 5" - 8" B Vent Diameters.	Fits most residential common vent systems.
Approved for installation in other manufacturers B Vent, with listed Cat I adapters available.	Unmatched installation flexibility.
SS flex has smooth inner wall.	Superior flow performance allowing longer runs before upsizing, and superior condensate management.
Corrosion resistant SS steel flex liner.	Withstands high temperatures inside Cat I vent.
Dual path (Cat I / Cat IV) termination cap.	Warm Cat I exhaust helps reduce icing on condensing Cat IV exhaust.
Engineered sizing guidance for combined system.	Addition of SS flex to "orphaned" common vent system helps reduce oversizing issues, enhances draft of remaining Cat I appliance.
Compatible with portfolio of Duravent special gas vent products, including PolyPro and FNS.	Utilize existing appliance adapters, current appliance approvals.
Vertical Termination.	Eliminates issues with Horizontal terminations, including wind effects, icing, code issues, etc.
Combined Cat I / Cat IV vent system takes up no additional space.	No additional building penetrations required, no disturbing finished internal spaces, etc.
UL tested, listed engineered system.	Industry first (and only) listing of it's kind.

STRAIGHT UP INSTALLATION

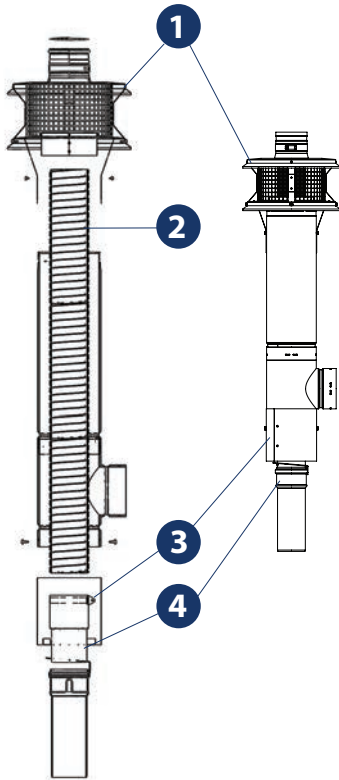

WYE INSTALLATION

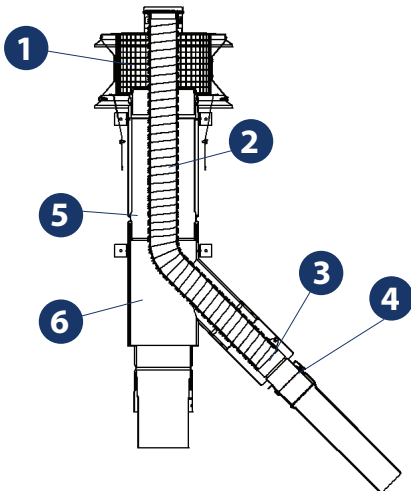

Description	Order #	Stock #
B-Vent Firestop 3		
3x2 B-Vent Firestop	FSFS-GVPP32	810012604
4x2 B-Vent Firestop	FSFS-GVPP42	810012605
4x3 B-Vent Firestop	FSFS-GVPP43	810012606
5x2 B-Vent Firestop	FSFS-GVPP52	810012607
5x3 B-Vent Firestop	FSFS-GVPP53	810012608
5x4 B-Vent Firestop	FSFS-GVPP54	810012609
6x2 B-Vent Firestop	FSFS-GVPP62	810012610
6x3 B-Vent Firestop	FSFS-GVPP63	810012611
6x4 B-Vent Firestop	FSFS-GVPP64	810012612
6x5 B-Vent Firestop	FSFS-GVPP65	810012613
Universal Female Adapter 5		
3" Female Adapter	3BVAF	810017784
4" Female Adapter	4BVAF	810017855
5" Female Adapter	5BVAF	810017944
6" Female Adapter	6BVAF	810018032
7" Female Adapter	7BVAF	810018122
8" Female Adapter	8BVAF	810018192
Double Wall Wye 45° Branch 6		
4"x4"x3" Double Wall Wye	4BYY43	810017896
4"x4"x4" Double Wall Wye	4BYY44	810017901
4"x3"x4" Double Wall Wye	4BYY34	810017888
5"x3"x4" Double Wall Wye	5BYY34	810017961
5"x4"x4" Double Wall Wye	5BYY44	810017972
5"x4"x5" Double Wall Wye	5BYY45	810017985
6"x3"x4" Double Wall Wye	6BYY34	810018040
6"x4"x3" Double Wall Wye	6BYY43	810018053
6"x4"x4" Double Wall Wye	6BYY44	810018055
6"x4"x5 Double Wall Wye	6BYY45	810018064
6"x3"x5" Double Wall Wye	6BYY35	810018050
6"x4"x6" Double Wall Wye	6BYY46	810018077

	Annular Space - Effective Remaining B Vent Diameter			
	02" Cat IV Liner	03" Cat IV Liner	04" Cat IV Liner	05" Cat IV Liner
5" B Vent	4"	3"	N/A	N/A
6" B Vent	5"	4"	4"	N/A
7" B Vent	6"	5"	5"	4"
8" B Vent	6"	6"	6"	5"

Description	Order #	Stock #
Vertical Terminations 1		
05"x2" Combo Cap	FSCC52	810010327
05"x3" Combo Cap	FSCC53	810010328
06"x2" Combo Cap	FSCC62	810010329
06"x3" Combo Cap	FSCC63	810010330
06"x4" Combo Cap	FSCC64	810010331
07"x2" Combo Cap	FSCC72	810010332
07"x3" Combo Cap	FSCC73	810010333
07"x4" Combo Cap	FSCC74	810010334
08"x2" Combo Cap	FSCC82	810010335
08"x3" Combo Cap	FSCC83	810010336
08"x4" Combo Cap	FSCC84	810010337
07"x5" Combo Cap	FSCC75	810012622
08"x5" Combo Cap	FSCC85	810012623
FasNSeal Flex 2		
02"x20' FasNSeal Flex	2FSFLEX-20	810012522
02"x25' FasNSeal Flex	2FSFLEX-25	810012523
02"x30' FasNSeal Flex	2FSFLEX-30	810012524
02"x35' FasNSeal Flex	2FSFLEX-35	810012525
02"x50' FasNSeal Flex	2FSFLEX-50	810012558
02"x200' FasNSeal Flex	2FSFLEX-200	810012559
02"x20' FasNSeal Flex	2FSFLEX-200	810012559
03" x 20' FasNSeal Flex	3FSFLEX-20	810003100
03" x 25' FasNSeal Flex	3FSFLEX-25	810003101
03" x 30' FasNSeal Flex	3FSFLEX-30	810003102
03" x 35" FasNSeal Flex	3FSFLEX-35	810003103
03" x 200" FasNSeal Flex	3FSFLEX-200	810003104
04" x 20' FasNSeal Flex	4FSFLEX-20	810003151
04" x 25' FasNSeal Flex	4FSFLEX-25	810003152
04" x 30' FasNSeal Flex	4FSFLEX-30	810003153
04" x 35" FasNSeal Flex	4FSFLEX-35	810003154
04" x 200" FasNSeal Flex	4FSFLEX-200	810003155
05" x 20' FasNSeal Flex	5FSFLEX-20	810003208
05" x 25' FasNSeal Flex	5FSFLEX-25	810003209
05" x 30' FasNSeal Flex	5FSFLEX-30	810003210
05" x 35" FasNSeal Flex	5FSFLEX-35	810003211
05" x 125" FasNSeal Flex	5FSFLEX-125	810003212
PP to FNS Flex Adapter		
2" PP to FNS Flex Adapter	FSASMM-PP-2	81000 4
3" PP to FNS Flex Adapter	FSASMM-PP-3	810010261
4" PP to FNS Flex Adapter	FSASMM-PP-4	810010262
5" PP to FNS Flex Adapter	FSASMM-PP-5	810010263

Specifications

Applications

FasNSeal and FasNSeal Flex is for use with natural gas or propane Categories II, III and IV appliances or Canada's Type BH Gas Vent Systems, having a maximum rated operating temperature of 480°F and a maximum positive pressure of 15" (FasNSeal Flex 6") water column. FasNSeal can be used on a wide range of applications, including: high efficiency gas boilers, furnaces, booster heaters, pool heaters, water heaters, unit heaters, or tankless water heaters.

FasNSeal W2 is ideal for use on commercial applications such as: office buildings, medical facilities, condos, or multiple unit apartment complexes where there is the need for low clearances to combustibles. In residential applications, FasNSeal W2 is the perfect solution for running between floor joists or in walls.

Materials and Construction

FasNSeal

3"-7": 29-4C or 316L .016"

8"-12": 29-4C or 316L .019"

14"-16": 29-4C or 316L .024"

FasNSeal Flex

Single strip double layer super-ferritic stainless steel (totaling .010").

FasNSeal W2

3"-6": 29-4C or 316L stainless steel .016" inner wall, stainless steel .016" outer wall.

7": 29-4C or 316L stainless steel .016" inner wall, stainless steel .024" outer wall.

8"-12": 29-4C or 316L stainless steel .019" inner wall, stainless steel .024" outer wall.

14"-16": 29-4C or 316L stainless steel .024" inner wall, stainless steel .024" outer wall.

Diameters

FasNSeal (single- and double-wall) 3"-16"

FasNSeal Flex 3"-12"

Listings

FasNSeal (single- and double-wall)

UL Listed to UL 1738 and ULC S636.

FasNSeal Flex UL Listed to UL 1738 and

UL 1777 and ULC S636.

UL 1738 and ULC S636 Systems

FasNSeal & FasNSeal W2

All FasNSeal (single-wall) and FasNSeal W2 (double-wall) vent lengths and components feature patented built-in mechanical locking band and triple-lipped directional gaskets. All pipes and components are engineered with smooth clean welds located 90° from mechanical locking bands. This construction feature allows for ease of installation. The 1/2" air space between the inner and outer wall on FasNSeal W2 helps to reduce the clearance to combustibles in addition to creating a heat shield for additional safety.

All FasNSeal components which come in contact with exhaust gases and condensates are now silicone free. This important design and manufacturing feature greatly reduces the chances of system breakdown and failure. The main problems with silicone are there are too many adhesion factors which are very difficult to control and the process of binding similar materials with an epoxy, which can weaken the bond over time. Welded seams ensure a leak-free product that is meant to last.

FasNSeal Flex

Made from super-ferritic stainless steel. Corrosion resistant.

Manufactured with a sure-seal locking seam for superior strength and flexibility. The smooth inner-wall provides for no output reduction, allowing for full appliance efficiency, ease of cleaning and regular maintenance. The smooth inner wall optimizes gas flow, minimizes back pressure, and facilitates condensate management. Flexible chimney liner is listed to UL 1738 standard.



Typical Installations

Installation Key

1	Rain Cap	9	Universal Condensate Drain
2	Storm Collar	10	Appliance Adapter
3	Variable Pitch Roof Flashing	11	Top Plate*
4	Vent Length	12	Female Flex Adapter
5	Adjustable Vent Length	13	FasNSeal Flex
6	Firestop/Flat Flashing	14	Male Flex Adapter
7	Horizontal Drip Tee	15	Standard Tee
8	Elbow		

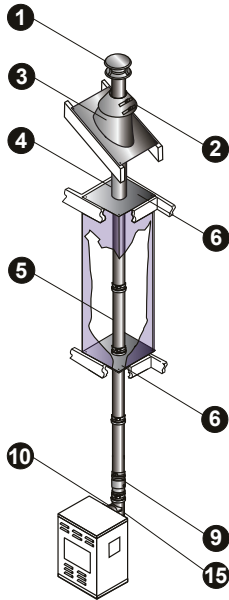

Multi-Story
FasNSeal

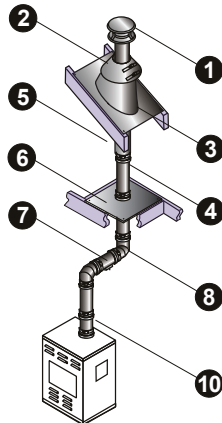

Offset
FasNSeal

Refer to our Typical Venting Installation drawings to select the appropriate component parts for your installation.

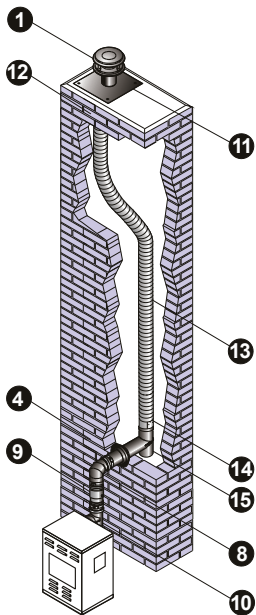

Offset with Tee
FasNSeal Flex & FasNSeal

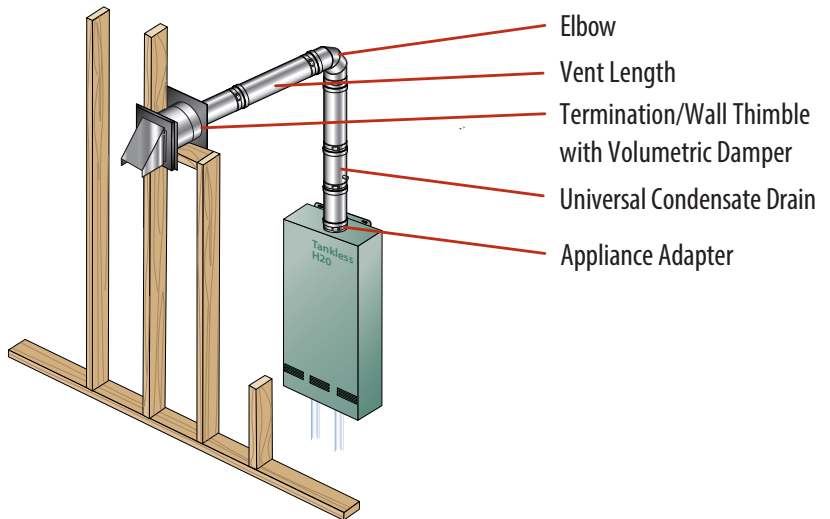

Commercial Applications

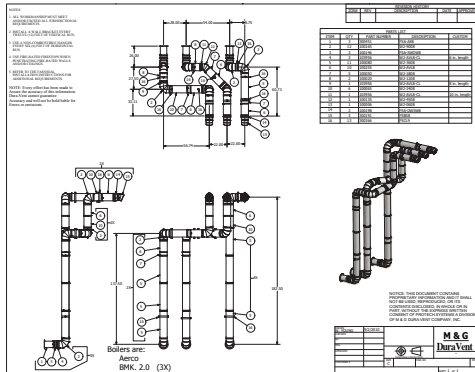

Commercial projects may require custom parts and unique system designs. Duravent offers complete project assistance:

- **Engineering Services:** Personalized system design services offer comprehensive CAD submittal drawing and complete bills of materials.
- **Custom Parts:** If your project requires innovative solutions, contact Duravent for custom parts that meet your specific project needs.
- **FasNSeal W2:** FasNSeal W2 is the ideal choice for commercial applications where there is a need for low clearances to combustibles.
- **Up to 16" Vent Diameters:** Many commercial applications require large diameter systems due to the unit's size and output. Large diameters are available in single and double wall, featuring FasNSeal's triple lipped directional gaskets and built-in locking band which provides a safe and convenient installation.

Clearances Chart

FasNSeal					
Rated Operating Temperatures		Enclosed		Unenclosed	
		Horizontal	Vertical	Horizontal	Vertical
3" - 4"	194°F \ 90°C (Canada Only)	0"		0"	
	300°F / 149°C	Sides: 8" Top: 12" Bottom: 4"	4"	1"	
	480°F / 249°C			3"	1"
5" - 16"	194°F / 90°C (Canada Only)	0"		0"	
	300°F \ 149°C	Noncombustible Enclosure		3"	3"
	480°F \ 249°C			3"	3"
FasNSeal W2					
Rated Operating Temperatures		Enclosed		Unenclosed	
		Horizontal	Vertical	Horizontal	Vertical
3" - 4"	194°F (Canada Only)	0"	0"	0"	0"
	300°F	3"	1"	1"	1"
	400°F	6"	1"	3"	1"
	480°F	6"	4"	3"	1"
5" - 16"	194°F (Canada Only)	0"	0"	0"	0"
	300°F	3"	1"	1"	1"
	400°F	6"	1"	3"	1"
	480°F	6"	6"	3"	3"
Rated Operating Temperature of 300°F = Max Flue Gas Temperature of 375°F					
Rated Operating Temperature of 480°F = Max Flue Gas Temperature of 550°F					

FasNSeal® - Single-Wall

Vent Length

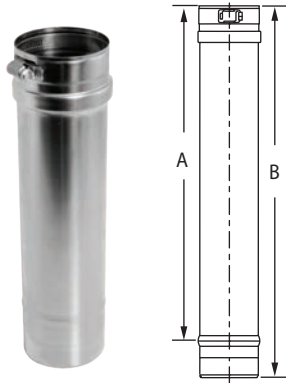

Use to vent category II, III and IV appliances.

Available in 316L Stainless Steel

Note: 48" lengths only available in 316L Stainless Steel.

SIZE	ORDER #	STOCK #	A	B	SIZE	ORDER #	STOCK #	A	B
3"	FSVL603	810003091	4"	6"	8"	FSVL2408	810003346	22"	24"
3"	FSVL1203	810003092	10"	12"	8"	FSVL3608	810003347	34"	36"
3"	FSVL1803	810003093	16"	18"	8"	FSVL4808B	810016459	46"	48"
3"	FSVL2403	810003094	22"	24"	9"	FSVL609	810003388	4"	6"
3"	FSVL3603	810003095	34"	36"	9"	FSVL1209	810003389	10"	12"
4"	FSVL604	810003142	4"	6"	9"	FSVL1809	810003390	16"	18"
4"	FSVL1204	810003143	10"	12"	9"	FSVL2409	810003391	22"	24"
4"	FSVL1804	810003144	16"	18"	9"	FSVL3609	810003392	34"	36"
4"	FSVL2404	810003145	22"	24"	9"	FSVL4809B	810016460	46"	48"
4"	FSVL3604	810003146	34"	36"	10"	FSVL610	810003426	4"	6"
5"	FSVL605	810003200	4"	6"	10"	FSVL1210	810003427	10"	12"
5"	FSVL1205	810003201	10"	12"	10"	FSVL1810	810003428	16"	18"
5"	FSVL1805	810003202	16"	18"	10"	FSVL2410	810003429	22"	24"
5"	FSVL2405	810003203	22"	24"	10"	FSVL3610	810003430	34"	36"
5"	FSVL3605	810003204	34"	36"	12"	FSVL612	810003467	4"	6"
5"	FSVL4805B	810016456	46"	48"	12"	FSVL1212	810003468	10"	12"
6"	FSVL606	810003255	4"	6"	12"	FSVL1812	810003469	16"	18"
6"	FSVL1206	810003256	10"	12"	12"	FSVL2412	810003470	22"	24"
6"	FSVL1806	810003257	16"	18"	12"	FSVL3612	810003471	34"	36"
6"	FSVL2406	810003258	22"	24"	14"	FSVL614	810003508	4"	6"
6"	FSVL3606	810003259	34"	36"	14"	FSVL1214	810003509	10"	12"
6"	FSVL4806B	810016457	46"	48"	14"	FSVL1814	810003510	16"	18"
7"	FSVL607	810003301	4"	6"	14"	FSVL2414	810003511	22"	24"
7"	FSVL1207	810003302	10"	12"	14"	FSVL3614	810003512	34"	36"
7"	FSVL1807	810003303	16"	18"	16"	FSVL616	810003543	4"	6"
7"	FSVL2407	810003304	22"	24"	16"	FSVL1216	810003544	10"	12"
7"	FSVL3607	810003305	34"	36"	16"	FSVL1816	810003545	16"	18"
7"	FSVL4807B	810016458	46"	48"	16"	FSVL2416	810003546	22"	24"
8"	FSVL608	810003343	4"	6"	16"	FSVL3616	810003547	34"	36"
8"	FSVL1208	810003344	10"	12"					
8"	FSVL1808	810003345	16"	18"					

Adjustable Vent Length

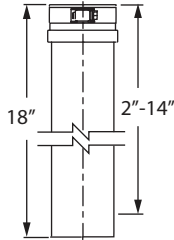

Use to add length to straight length of FasNSeal pipe. Adds 2"-14" of length. Requires at least 4" overlap for a secure connection.

Available in Custom Lengths.

Available in 316L Stainless Steel

SIZE	ORDER #	STOCK #	SIZE	ORDER #	STOCK #
3"	FSAVL3	810003097	9"	FSAVL9	810003393
4"	FSAVL4	810003148	10"	FSAVL10	810003431
5"	FSAVL5	810003205	12"	FSAVL12	810003472
6"	FSAVL6	810003260	14"	FSAVL14	810003513
7"	FSAVL7	810003306	16"	FSAVL16	810003548
8"	FSAVL8	810003348			

2° Adjustable Vent Length

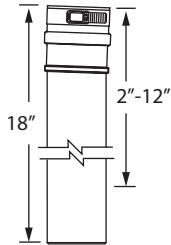

Use to facilitate for the 2° pitched required in horizontal runs.

Available in 316L Stainless Steel

SIZE	ORDER #	STOCK #	SIZE	ORDER #	STOCK #
3"	FSAVL03-2	810003099	9"	FSAVL09-2	810003395
4"	FSAVL04-2	810003150	10"	FSAVL10-2	810003433
5"	FSAVL05-2	810003207	12"	FSAVL12-2	810003474
6"	FSAVL06-2	810003262	14"	FSAVL14-2	810003515
7"	FSAVL07-2	810003308	16"	FSAVL16-2	810003550
8"	FSAVL08-2	810003350			

FasNSeal Flex



Use to vent Category II, III, and IV gas burning appliances. Listed to UL 1738. Can only be used in vertical or near vertical runs. Use with FasNSeal components only.

SIZE	20'		25'		30'		35'	
	Order #	Stock #	Order #	Stock #	Order #	Stock #	Order #	Stock #
3"	3FSFLEX-20	810003100	3FSFLEX-25	810003101	3FSFLEX-30	810003102	3FSFLEX-35	810003103
4"	4FSFLEX-20	810003151	4FSFLEX-25	810003152	4FSFLEX-30	810003153	4FSFLEX-35	810003154
5"	5FSFLEX-20	810003208	5FSFLEX-25	810003209	5FSFLEX-30	810003210	5FSFLEX-35	810003211
6"	6FSFLEX-20	810003263	6FSFLEX-25	810003264	6FSFLEX-30	810003265	6FSFLEX-35	810003266
7"	7FSFLEX-20	810003309	7FSFLEX-25	810003310	7FSFLEX-30	810003311	7FSFLEX-35	810003312
8"	8FSFLEX-20	810003351	8FSFLEX-25	810003352	8FSFLEX-30	810003353	8FSFLEX-35	810003354
SIZE	50'		100'		125'		200'	
	Order #	Stock #	Order #	Stock #	Order #	Stock #	Order #	Stock #
3"	--	--	--	--	--	--	3FSFLEX-200	810003104
4"	--	--	--	--	--	--	4FSFLEX-200	810003155
5"	--	--	--	--	5FSFLEX-125	810003212	--	--
6"	--	--	6FSFLEX-100	810003267	--	--	--	--
8"	8FSFLEX-50	810003355	--	--	--	--	--	--

FasNSeal Flex Rain Cap



Terminates FS Flex with support.

SIZE	ORDER #	STOCK #	A	B	SIZE	ORDER #	STOCK #	A	B
2"	FSFLEXRC2	810013324	7 5/8"	6 3/4"	7"	FSFLEXRC7	810013293	14 5/8"	6 3/4"
3"	FSFLEXRC3	810013289	7 5/8"	6"	8"	FSFLEXRC8	810013294	15 5/8"	7"
4"	FSFLEXRC4	810013290	8 5/8"	6"	9"	FSFLEXRC9	810013295	16 5/8"	7 3/4"
5"	FSFLEXRC5	810013291	10 5/8"	6 1/2"	10"	FSFLEXRC10	810013296	18 5/8"	8"
6"	FSFLEXRC6	810013292	11 5/8"	6 1/2"	12"	FSFLEXRC12	810013297	20 5/8"	8"

FasNSeal Flex Top Cover Plates

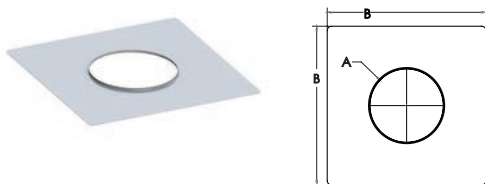

Supports FSFLEXRC Terminations.

SIZE	ORDER #	STOCK #	A	B	SIZE	ORDER #	STOCK #	A	B
2"	FSFLEXP2	810013325	2 1/2"	16"	7"	FSFLEXP7	810013330	7 3/16"	18"
3"	FSFLEXP3	810013326	3 3/16"	18"	8"	FSFLEXP8	810013331	8 3/16"	18"
4"	FSFLEXP4	810013327	4 3/16"	18"	9"	FSFLEXP9	810013332	9 3/16"	18"
5"	FSFLEXP5	810013323	5 3/16"	18"	10"	FSFLEXP10	810013333	10 3/16"	18"
6"	FSFLEXP6	810013329	6 3/16"	18"	12"	FSFLEXP12	810013334	12 3/16"	18"

FasNSeal Flex Coupler

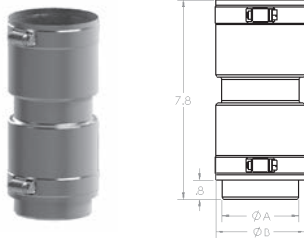

Used to connect two (2) lengths of FasNSeal Flex together.

Available in 316L Stainless Steel

SIZE	ORDER #	STOCK #	A	B	SIZE	ORDER #	STOCK #	A	B
2"	FSAFLEXC-2	810010308	1 13/16"	2 3/8"	7"	FSAFLEXC-7	810012817	6 13/16"	7 3/8"
3"	FSAFLEXC-3	810012560	3"	3 1/2"	8"	FSAFLEXC-8	810012564	7 13/16"	8 3/8"
4"	FSAFLEXC-4	810012561	3 13/16"	4 3/8"	9"	FSAFLEXC-9	810012565	8 13/16"	9 5/16"
5"	FSAFLEXC-5	810012562	4 13/16"	5 3/8"	10"	FSAFLEXC-10	810012566	9 13/16"	10 5/16"
6"	FSAFLEXC-6	810012563	5 13/16"	6 3/8"	12"	FSAFLEXC-12	810012567	11 13/16"	12 5/16"

Male Flex Adapter

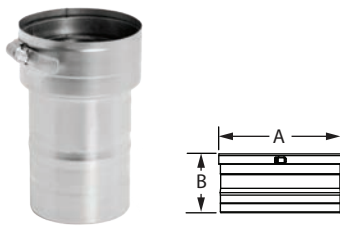

Use to connect FasNSeal rigid Vent Pipe to FasNSeal Flex at base of masonry chimney or bottom termination.

Available in 316L Stainless Steel

SIZE	ORDER #	STOCK #	A	B	SIZE	ORDER #	STOCK #	A	B
3"	FSASMM-3	810003140	2 13/16"	3 5/16"	8"	FSASMM-8	810003386	7 13/16"	8 5/16"
4"	FSASMM-4	810003198	3 13/16"	4 5/16"	9"	FSASMM-9	810003424	8 13/16"	9 5/16"
5"	FSASMM-5	810003247	4 13/16"	5 5/16"	10"	FSASMM-10	810003465	9 13/16"	10 5/16"
6"	FSASMM-6	810003299	5 13/16"	6 5/16"	12"	FSASMM-12	810003506	11 13/16"	12 5/16"
7"	FSASMM-7	810003341	6 13/16"	7 5/16"					

PolyPro Rigid to FasNSeal Flex Adapter

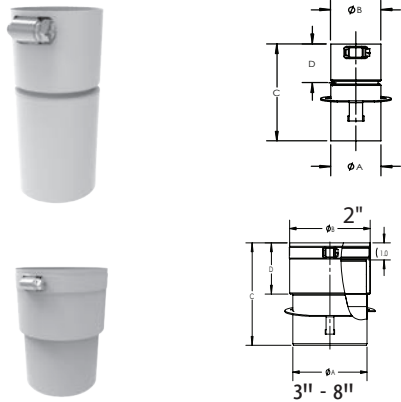

Use to connect FasNSeal Flex to PolyPro rigid Vent Pipe at the bottom of the system. ***Available in 316L Stainless Steel***

SIZE	ORDER #	STOCK #	A	B	C	D
2"	FSASMM-PP-2	810009850	2 7/16"	2 7/16"	5"	2"
3"	FSASMM-PP-3	810010261	3 3/16"	3 1/2"	6"	3"
4"	FSASMM-PP-4	810010262	3 15/16"	4 7/16"	6"	3"
5"	FSASMM-PP-5	810010263	5 1/8"	5 7/16"	6"	3"
6"	FSASMM-PP-6	810010264	5 15/16"	6 7/16"	6"	3"
8"	FSASMM-PP-8	810010265	7 15/16"	8 7/16"	7"	3"

Female Flex Adapter

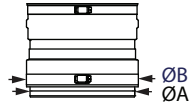

Use to connect FasNSeal Flex to FasNSeal rigid Vent Pipe at the top of the system. ***Available in 316L Stainless Steel***

SIZE	ORDER #	STOCK #	A	B	SIZE	ORDER #	STOCK #	A	B
3"	FSASMF-3	810003141	2 13/16"	3 3/16"	8"	FSASMF-8	810003387	7 13/16"	8 1/5"
4"	FSASMF-4	810003199	3 13/16"	4 3/16"	9"	FSASMF-9	810003425	8 13/16"	9 1/5"
5"	FSASMF-5	810003248	4 13/16"	5 3/16"	10"	FSASMF-10	810003466	9 13/16"	10 3/16"
6"	FSASMF-6	810003300	5 13/16"	6 3/16"	12"	FSASMF-12	810003507	11 3/16"	12 3/16"
7"	FSASMF-7	810003342	6 13/16"	7 3/16"					

Test Port

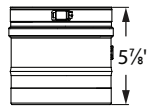

Use to test for proper appliance operation without penetrating the vent wall. Easy access to perform flue gas analysis. More options available, see Universal Adapter w/Test Port in FasNSeal Appliance Adapter section. ***Available in 316L Stainless Steel***

SIZE	ORDER #	STOCK #	SIZE	ORDER #	STOCK #
3"	FSTP03	810003135	9"	FSTP09	810003422
4"	FSTP04	810003196	10"	FSTP10	810003463
5"	FSTP05	810003245	12"	FSTP12	810003504
6"	FSTP06	810003297	14"	FSTP14	810003541
7"	FSTP07	810003339	16"	FSTP16	810003575
8"	FSTP08	810003384			

90° Elbow

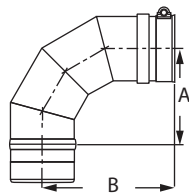

Use to go from horizontal to vertical runs or vertical to horizontal runs. Use to turn vent 90°. ***Available in 316L Stainless Steel***

SIZE	ORDER #	STOCK #	A	B	SIZE	ORDER #	STOCK #	A	B
3"	FSELB9003	810003106	4"	6"	9"	FSELB9009	810003397	7"	9"
4"	FSELB9004	810003157	4 1/2"	6 1/4"	10"	FSELB9010	810003435	7 1/2"	9 3/8"
5"	FSELB9005	810003214	5"	6 3/4"	12"	FSELB9012	810003476	8 1/2"	10 1/4"
6"	FSELB9006	810003269	5 1/2"	7 1/2"	14"	FSELB9014	810003516	9 1/2"	11 3/8"
7"	FSELB9007	810003315	6 1/8"	7 7/8"	16"	FSELB9016	810003551	11"	12 1/2"
8"	FSELB9008	810003357	6 1/2"	8 1/4"					

88° Elbow

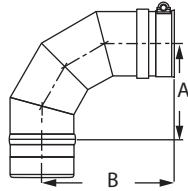

Use to transition from a vertical to a horizontal run. Stabilizes a 2° pitch towards the condensate drain for good condensate management. ***Available in 316L Stainless Steel***

SIZE	ORDER #	STOCK #	A	B	SIZE	ORDER #	STOCK #	A	B
3"	FSELB8803	810003107	4"	6"	9"	FSELB8809	810003398	7"	9"
4"	FSELB8804	810003158	4 1/2"	6 1/4"	10"	FSELB8810	810003436	7 1/2"	9 3/8"
5"	FSELB8805	810003215	5"	6 3/4"	12"	FSELB8812	810003477	8 1/2"	10 1/4"
6"	FSELB8806	810003270	5 1/2"	7 1/2"	14"	FSELB8814	810003517	9 1/2"	11 3/8"
7"	FSELB8807	810003316	6 1/8"	7 7/8"	16"	FSELB8816	810003552	11"	12 1/2"
8"	FSELB8808	810003358	6 1/2"	8 1/4"					

45° Elbow

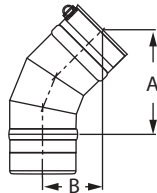

Offsets obstructions as needed. Allows for better condensate management and less back pressure.

Available in 316L Stainless Steel

SIZE	ORDER #	STOCK #	A	B	SIZE	ORDER #	STOCK #	A	B
3"	FSELB4503	810003108	5 3/8"	3"	12"	FSELB4512	810003478	8 1/2"	4 1/4"
4"	FSELB4504	810003159	5 5/8"	3 1/8"	14"	FSELB4514	810003518	9 1/4"	4 5/8"
5"	FSELB4505	810003216	6"	3 1/4"	16"	FSELB4516	810003553	10"	4 7/8"
6"	FSELB4506	810003271	6 3/8"	3 3/8"					
7"	FSELB4507	810003317	6 3/4"	3 1/2"					
8"	FSELB4508	810003359	7 1/8"	3 5/8"					
9"	FSELB4509	810003399	7 1/2"	3 7/8"					
10"	FSELB4510	810003437	7 7/8"	4"					

30° Elbow

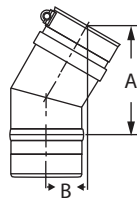

Offsets obstructions as needed. Allows for better condensate management and less back pressure.

Available in 316L Stainless Steel

SIZE	ORDER #	STOCK #	A	B	SIZE	ORDER #	STOCK #	A	B
3"	FSELB3003	810003109	4 7/8"	1 7/8"	9"	FSELB3009	810003400	7"	2 1/2"
4"	FSELB3004	810003160	5 1/8"	1 7/8"	10"	FSELB3010	810003438	6 1/2"	2 1/4"
5"	FSELB3005	810003217	5 1/4"	2"	12"	FSELB3012	810003479	7"	2 1/2"
6"	FSELB3006	810003272	5 1/2"	2"	14"	FSELB3014	810003519	7 1/2"	2 1/2"
7"	FSELB3007	810003318	5 7/8"	2"	16"	FSELB3016	810003554	8 1/8"	2 3/4"
8"	FSELB3008	810003360	6 1/8"	2 1/8"					

15° Elbow

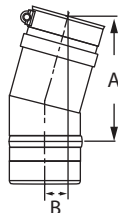

Offsets obstructions as needed. Allows for better condensate management and less back pressure.

Available in 316L Stainless Steel

SIZE	ORDER #	STOCK #	A	B	SIZE	ORDER #	STOCK #	A	B
3"	FSELB1503	810003110	4 3/8"	7/8"	9"	FSELB1509	810003401	5 1/4"	1"
4"	FSELB1504	810003161	4 1/2"	1"	10"	FSELB1510	810003439	5 1/4"	1"
5"	FSELB1505	810003218	4 5/8"	7/8"	12"	FSELB1512	810003480	5 1/2"	1"
6"	FSELB1506	810003273	4 3/4"	7/8"	14"	FSELB1514	810003520	5 3/4"	1"
7"	FSELB1507	810003319	4 7/8"	1"	16"	FSELB1516	810003555	6 1/8"	1"
8"	FSELB1508	810003361	5 1/8"	1"					

Wide Mouth Boot Tee

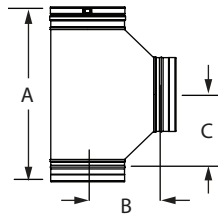

Use to transition from horizontal to vertical. Provides improved flue gas flow with angled gradual transitions. Can also be used as a manifold connection to gang boilers into a common vent.

Available in 316L Stainless Steel

SIZE	ORDER #	STOCK #	A	B	C
4"	FSWBT4	810003164	15 3/4"	7"	6 9/16"
5"	FSWBT5	810003220	16 3/4"	7 1/2"	7 3/16"
6"	FSWBT6	810003275	17 3/4"	8"	7 9/16"
7"	FSWBT7	810003321	18 3/4"	8 1/2"	8 3/16"
8"	FSWBT8	810003363	19 3/4"	9"	8 9/16"
9"	FSWBT9	810003403	20 3/4"	9 1/2"	9 3/16"
10"	FSWBT10	810003441	21 3/4"	10"	9 9/16"
12"	FSWBT12	810003482	23 3/4"	11"	10 9/16"
14"	FSWBT14	810003522	25 3/4"	12"	11 9/16"
16"	FSWBT16	810003557	27 3/4"	13"	12 9/16"

Standard Tee

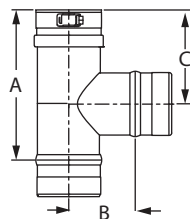

Use for a 90° offset, or to combine connections from two or more appliances into a common vent. Can also use as a condensate management point when used in conjunction with drain fitting. All Standard Tees are completely welded.

Available in 316L Stainless Steel

SIZE	ORDER #	STOCK #	A	B	C	SIZE	ORDER #	STOCK #	A	B	C
3"	FST3	810003111	7"	3"	4 1/2"	9"	FST9	810003402	14"	6"	8"
4"	FST4	810003162	8"	3 1/2"	5"	10"	FST10	810003440	14"	6 1/2"	8"
5"	FST5	810003219	10"	4"	6"	12"	FST12	810003481	16"	7"	9"
6"	FST6	810003274	10"	4 1/2"	6"	14"	FST14	810003521	20"	8 1/2"	11"
7"	FST7	810003320	12"	5"	7"	16"	FST16	810003556	22"	9 1/2"	12"
8"	FST8	810003362	14"	5 1/2"	8"						

Branch Tee

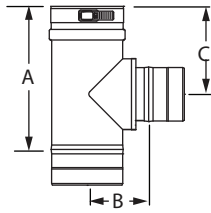

Use as a Tee increaser or as a manifold connection to gang boilers into a common vent. **Available in custom size combinations.**

SIZE	ORDER #	STOCK #	A	B	C
4" x 4" x 3"	FST04B03	810003112	8 1/10"	3 1/2"	5"
5" x 5" x 3"	FST05B03	810003113	8 1/10"	4"	5 3/5"
6" x 6" x 5"	FST06B05	810003222	10 1/5"	4 1/2"	5 3/4"

Single-Wall Wye



6" - 10" Diameters

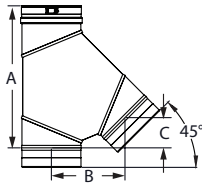

12" - 16" Diameters

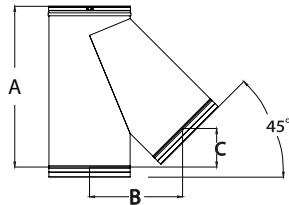

Use in place of any Duravent tee for a 45° angle instead of 90°; can be used as a manifold connection to gang multiple boilers into a common vent.

SIZE	ORDER #	STOCK #	A	B	C
6"	FSWYE06	810005506	14 1/2"	7 1/2"	3 1/8"
7"	FSWYE07	810007017	16 1/3"	8 3/5"	3 1/2"
8"	FSWYE08	810005507	18"	9 7/10"	4"
9"	FSWYE09	810005508	19 7/10"	10 7/10"	4 2/5"
10"	FSWYE10	810005509	21 2/5"	11 13/16"	4 15/16"
12"	FSWYE12	810005510	24 15/16"	14"	5 13/16"
14"	FSWYE14	810007018	28 3/10"	16 1/8"	6 3/5"
16"	FSWYE16	810009330	31 4/5"	18 1/5"	7 1/2"

Single-Wall Increaser Wye



6" - 10" Diameters

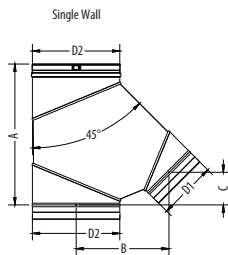

12" - 16" Diameters

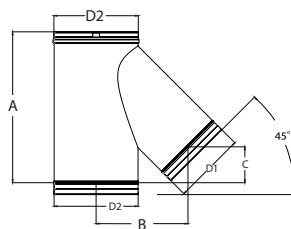

Use in place of any tee for a 45° angle instead of 90°. The branch has a smaller diameter, so it can be used to increase to a larger diameter as a manifold connection to gang multiple boilers into a common vent. Maximum diameter increase is 6". Available in custom size combinations.

SIZE	ORDER #	STOCK #	A	B	C
6" x 8"	FSWYE0608	810012530	15 3/8"	9 1/4"	3 3/8"
6" x 10"	FSWYE0610	810012531	16"	10 5/8"	3 5/8"
6" x 12"	FSWYE0612	810012556	17 1/8"	12 1/2"	4"
8" x 10"	FSWYE0810	810012532	18 3/4"	11 3/8"	4 3/8"
8" x 12"	FSWYE0812	810012533	19 3/8"	12 3/4"	4 1/2"
8" x 14"	FSWYE0814	810012557	20"	14 1/4"	4 5/8"
10" x 12"	FSWYE1012	810010236	22 1/4"	13 1/2"	5 1/8"
10" x 14"	FSWYE1014	810012534	22 7/8"	15"	5 3/8"
10" x 16"	FSWYE1016	810010311	23 1/2"	16 3/8"	5 1/2"
12" x 14"	FSWYE1214	810010055	25 3/8"	15 5/8"	6 1/8"

Tee Cap

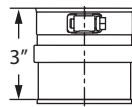

Use to cap Standard Tee, Branch Tee or Boot Tee. Remove Tee Cap to inspect the system; clean out debris or collected condensate.

Available in 316L Stainless Steel

SIZE	ORDER #	STOCK #	SIZE	ORDER #	STOCK #
3"	FSTC3	810003114	9"	FSTC9	810003405
4"	FSTC4	810003168	10"	FSTC10	810003443
5"	FSTC5	810003224	12"	FSTC12	810003484
6"	FSTC6	810003277	14"	FSTC14	810003524
7"	FSTC7	810003323	16"	FSTC16	810003559
8"	FSTC8	810003365			

Universal Condensate Drain

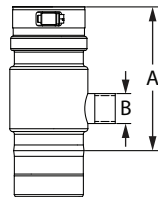

Use to properly manage corrosive condensates common with high efficiency gas appliances. For best results, install close to the appliance. Can be used horizontally, vertically, or any angle in between. The top photo shows the 3"-5" diameters with 5/8" straight tube; the bottom photo shows 6"-16" diameters with a 1" IPS Fitting.

Available in 316L Stainless Steel

SIZE	ORDER #	STOCK #	A	B
3"	FSUCD3	810003115	6 2/5"	5/8"
4"	FSUCD4	810003169	6 2/5"	5/8"
5"	FSUCD5	810003225	6 2/5"	5/8"
6"	FSUCD6	810003278	6 2/5"	1 1/4"
7"	FSUCD7	810003324	6 2/5"	1 1/4"
8"	FSUCD8	810003366	6 2/5"	1 1/4"
9"	FSUCD9	810003406	6 2/5"	1 1/4"
10"	FSUCD10	810003444	6 2/5"	1 1/4"
12"	FSUCD12	810003485	6 2/5"	1 1/4"
14"	FSUCD14	810003525	6 2/5"	1 1/4"
16"	FSUCD16	810003560	6 2/5"	1 1/4"

Drain Fitting

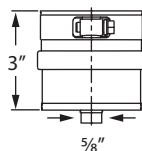

Use instead of Tee Cap to manage condensates at the bottom of a vertical run. For vent systems larger than 5", use an IPS Drain Fitting. ***Available in 316L Stainless Steel***

SIZE	ORDER #	STOCK #
3"	FSDF3	810003116
4"	FSDF4	810003170
5"	FSDF5	810003226

IPS Drain Fitting

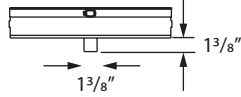

Use to connect iron drain pipe to flow acidic condensates to a neutralization tank before disposal. Uses 1" NPT thread.

Available in 316L Stainless Steel

SIZE	ORDER #	STOCK #	SIZE	ORDER #	STOCK #
3"	FSIPDF03	810003117	9"	FSIPDF09	810003407
4"	FSIPDF04	810003171	10"	FSIPDF10	810003445
5"	FSIPDF05	810003227	12"	FSIPDF12	810003486
6"	FSIPDF06	810003279	14"	FSIPDF14	810003526
7"	FSIPDF07	810003325	16"	FSIPDF16	810003561
8"	FSIPDF08	810003367			

Horizontal Drain Fitting

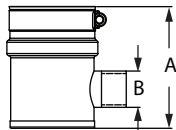

Use to manage condensates in horizontal runs. Optimal when ganging multiple appliances into a common vent. The top photo shows the 3"-5" diameters with 5/8" straight tube; the bottom photo shows 6"-16" diameters with a 1" IPS Fitting.

Available in 316L Stainless Steel

SIZE	ORDER #	STOCK #	A	B
3"	FSHDF03	810003118	3 1/2"	5/8"
4"	FSHDF04	810003172	3 1/2"	5/8"
5"	FSHDF05	810003228	3 1/2"	5/8"
6"	FSHDF06	810003280	4 3/8"	1 1/4"
7"	FSHDF07	810003326	4 3/8"	1 1/4"
8"	FSHDF08	810003368	4 3/8"	1 1/4"
9"	FSHDF09	810003408	4 3/8"	1 1/4"
10"	FSHDF10	810003446	4 3/8"	1 1/4"
12"	FSHDF12	810003487	4 3/8"	1 1/4"
14"	FSHDF14	810003527	4 3/8"	1 1/4"
16"	FSHDF16	810003562	4 3/8"	1 1/4"

Horizontal Drip Tee

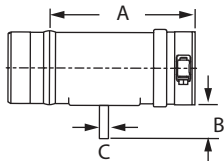

Use to manage condensate in horizontal runs.

Available in 316L Stainless Steel

SIZE	ORDER #	STOCK #	A	B	C
3"	FSHDT3	810003119	6"	1 1/2"	3/8"
4"	FSHDT4	810003173	6"	1 1/2"	3/8"

23° Bird Screen

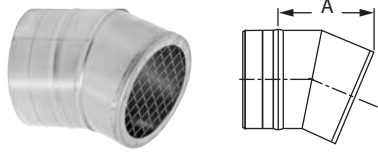

Use for 3" to 16" through-the-wall termination. Deters rain and other elements from entering the vent system. Check installation instructions for restrictions on horizontal terminations, such as minimum distance from windows and doors.

Available in 316L Stainless Steel

SIZE	ORDER #	STOCK #	A
3"	FSBS3	810014823	3 7/10"
4"	FSBS4	810014825	4 1/5"
5"	FSBS5	810003229	4 4/5"
6"	FSBS6	810003281	5 3/5"
7"	FSBS7	810003327	6 2/5"
8"	FSBS8	810003369	7 1/10"
9"	FSBS9	810003409	7 7/10"
10"	FSBS10	810003447	8 7/10"
12"	FSBS12	810003488	10 1/5"
14"	FSBS14	810003528	11 7/10"
16"	FSBS16	810003563	13 1/5"

Termination Tee

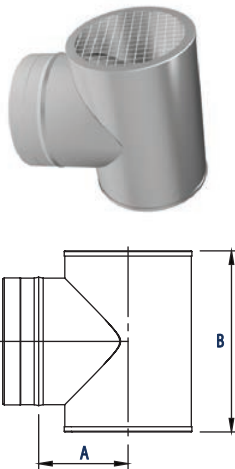

Use for standard and high-wind through-the-wall terminations. Check installation instructions for restrictions on horizontal terminations, such as minimum distance from windows and doors.

Available in 316L Stainless Steel

SIZE	ORDER #	STOCK #	A	B
3"	FSTT3	810003121	3"	6"
4"	FSTT4	810003175	3 1/2"	7"
5"	FSTT5	810003230	4"	8"
6"	FSTT6	810003282	4 1/2"	9"
7"	FSTT7	810014714	5"	10"
8"	FSTT8	810005266	5 1/2"	11"
9"	FSTT9	810014786	6"	12"
10"	FSTT10	810009492	6 1/2"	13"
12"	FSTT12	810014798	7 1/2"	15"
14"	FSTT14	810014800	8 1/2"	17"
16"	FSTT16	810014815	9 1/2"	19"

Termination Box

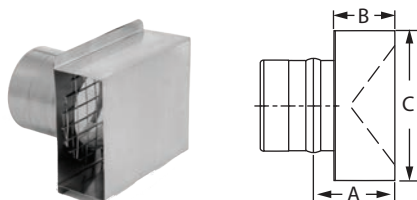

Use for horizontal through-the-wall terminations. Check installation instructions for restrictions on horizontal terminations, such as minimum distance from windows and doors.

Available in 316L Stainless Steel

SIZE	ORDER #	STOCK #	A	B	C
3"	FSTB3	810003122	2 3/10"	2"	5"
4"	FSTB4	810003176	2 3/10"	2"	6"

Insulated Wall Thimble w/ Termination Damper

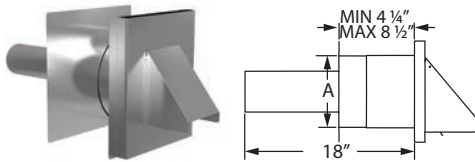

Use for horizontal through-the-wall terminations. Check installation instructions for restrictions on horizontal cap terminations, such as minimum distance from windows and doors. Accommodates wall thickness of 4 1/4" to 8 1/2". Damper prevents backdraft of cold air to appliance.

Available in 316L Stainless Steel

SIZE	ORDER #	STOCK #	A
3"	FSWTTI03	810016544	6"
4"	FSWTTI04	810016546	7"
5"	FSWTTI05	810016548	8"
6"	FSWTTI06	810016550	9"
8"	FSWTTI08	810016552	11"

Insulated Wall Thimble w/ AVL

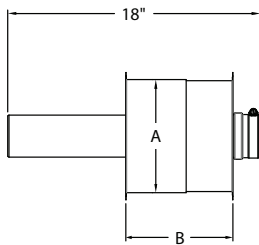

Use for through-the-wall termination. Fits between standard wall studs. 3"-5" diameters accommodate wall thickness of 4 1/4" to 8 1/2". 6"-16" diameters accommodate wall thickness of 5 3/4" to 11 1/2". AVL pipe allows for adjustability in length variance.

Available in 316L Stainless Steel

SIZE	ORDER #	STOCK #	A	B-MIN	B-MAX
3"	FSWTI03	810016484	8"	4.25"	8"
4"	FSWTI04	810016485	9"	4.25"	8.5"
5"	FSWTI05	810016486	10"	4.25"	8.5"
6"	FSWTI06	810016487	11"	5.75"	11.5"
7"	FSWTI07	810016488	12"	5.75"	11.5"
8"	FSWTI08	810016489	13"	5.75"	11.5"
9"	FSWTI09	810016490	14"	5.75"	11.5"
10"	FSWTI10	810016491	15"	5.75"	11.5"
12"	FSWTI12	810016492	17"	5.75"	11.5"
14"	FSWTI14	810016493	19"	5.75"	11.5"
16"	FSWTI16	810016494	21"	5.75"	11.5"

Insulated Wall Pass Through

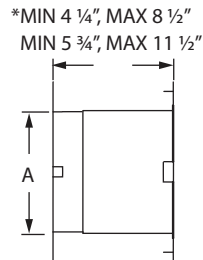

Use for through-the-wall termination. Fits between standard wall studs. 3"-5" diameters accommodate wall thickness of 4 1/4" to 8 1/2". 6"-16" diameters accommodate wall thickness of 5 3/4" to 11 1/2".

SIZE	ORDER #	STOCK #	A	SIZE	ORDER #	STOCK #	A
3"	FSWPTI03	810016473	6"	9"	FSWPTI09	810016479	12"
4"	FSWPTI04	810016474	7"	10"	FSWPTI10	810016480	13"
5"	FSWPTI05	810016475	8"	12"	FSWPTI12	810016481	15"
6"	FSWPTI06	810016476	9"	14"	FSWPTI14	810016482	17"
7"	FSWPTI07	810016477	10"	16"	FSWPTI16	810016483	19"
8"	FSWPTI08	810016478	11"				

Wall Thimble Sleeve Extension

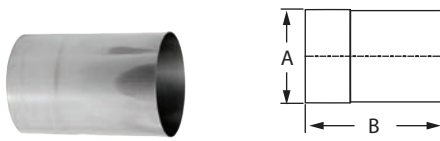

Use to add 6" of length to Wall Pass Through and Wall Thimble for thicker walls.

SIZE	ORDER #	STOCK #	A
3"	FSWTE3	810003126	6"
4"	FSWTE4	810003180	7"
5"	FSWTE5	810003233	8"
6"	FSWTE6	810003286	9"
7"	FSWTE7	810003330	10"
8"	FSWTE8	810003373	11"
9"	FSWTE9	810003412	12"
10"	FSWTE10	810003450	13"
12"	FSWTE12	810003491	15"
14"	FSWTE14	810003531	17"
16"	FSWTE16	810003566	19"

Firestop/Flat Flashing

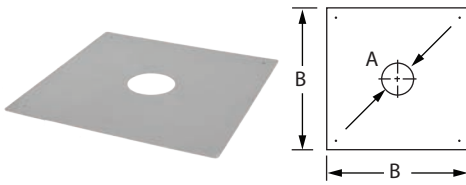

Use when penetrating floor levels.

SIZE	ORDER #	STOCK #	A	B	SIZE	ORDER #	STOCK #	A	B
3"	FSFS3	810003127	3 3/5"	15"	9"	FSFS9	810003413	9 3/5"	22"
4"	FSFS4	810003181	4 3/5"	15"	10"	FSFS10	810003451	10 3/5"	22"
5"	FSFS5	810003234	5 3/5"	17"	12"	FSFS12	810003492	12 3/5"	24"
6"	FSFS6	810003287	6 3/5"	17"	14"	FSFS14	810003532	14 3/5"	26"
7"	FSFS7	810003331	7 3/5"	19"	16"	FSFS16	810003567	16 3/5"	28"
8"	FSFS8	810003374	8 3/5"	19"					

Support Clamp



Use to support vertical and horizontal runs using threaded rod. Recommended every 10' on vertical runs and every 6' in horizontals. Use additional Support Clamps as needed.

SIZE	ORDER #	STOCK #	A	SIZE	ORDER #	STOCK #	A
3"	FSCL3	810003128	1 1/2"	9"	FSCL9	810003414	1 1/2"
4"	FSCL4	810003182	1 1/2"	10"	FSCL10	810003452	1 1/2"
5"	FSCL5	810003288	1 1/2"	12"	FSCL12	810003493	1 1/2"
6"	FSCL6	810003288	1 1/2"	14"	FSCL14	810003533	1 1/2"
7"	FSCL7	810003332	1 1/2"	16"	FSCL16	810003568	1 1/2"
8"	FSCL8	810003375	1 1/2"				

Wall Bracket

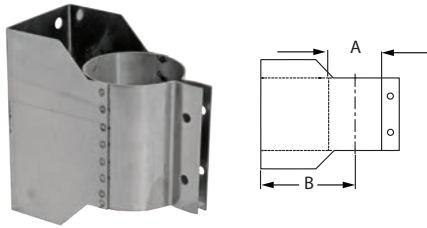

Use to support vent pipe or tee sections. Provides proper clearance to combustibles.

SIZE	ORDER #	STOCK #	A	B	SIZE	ORDER #	STOCK #	A	B
3"	FSWB3	810003129	3"	3 1/2"	9"	FSWB9	810003415	9"	6 1/2"
4"	FSWB4	810003183	4"	4"	10"	FSWB10	810003453	10"	7"
5"	FSWB5	810003236	5"	4 1/2"	12"	FSWB12	810003494	12"	8"
6"	FSWB6	810003289	6"	5"	14"	FSWB14	810003534	14"	9"
7"	FSWB7	810003333	7"	5 1/2"	16"	FSWB16	810003569	16"	10"
8"	FSWB8	810003376	8"	6"					

Adjustable Wall Bracket

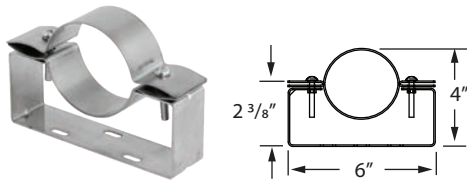

Use to support vent pipe in lateral and horizontal runs. Assist in achieving proper pitch for condensate management. Adjusts up to 3\".

SIZE	ORDER #	STOCK #
3"	FSAWB03	810003130
4"	FSAWB04	810003184

Rain Cap

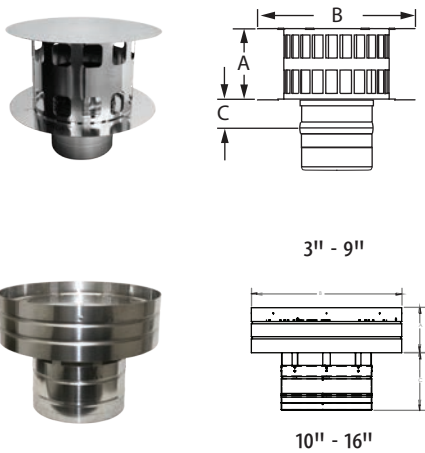

Use to terminate above the roof line. When terminating above 12\"/>

SIZE	ORDER #	STOCK #	A	B	C
3"	FSRC3	810003131	3 1/2"	6 4/5"	1"
4"	FSRC4	810003185	4 1/2"	8 9/10"	1"
5"	FSRC5	810003237	5 4/5"	11 3/10"	1"
6"	FSRC6	810003292	6 4/5"	13 1/2"	1"
7"	FSRC7	810003334	7 4/5"	15 4/5"	1"
8"	FSRC8	810003377	8 4/5"	18"	1"
9"	FSRC9	810003416	10"	20 3/10"	1"
10"	FSRC10	810012600	5"	16 3/4"	5 3/8"
12"	FSRC12	810009873	6"	20"	5 5/8"
14"	FSRC14	810009874	7"	23 1/2"	6"
16"	FSRC16	810009875	8"	26 3/4"	6 1/3"

Severe Weather Rain Cap

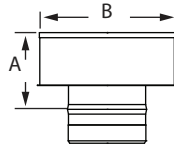

Use where high winds and horizontal rain are present. For vertical termination only. ***Available in 316L Stainless Steel***

SIZE	ORDER #	STOCK #	A	B
4"	FSSWRC04	810003186	6"	7 1/10"

Termination Cone

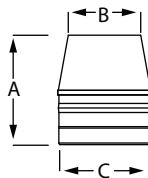

Use for vertical termination. Creates static back pressure to adjust harmonics. Venturi effect increases velocity of flue gases. Reduced opening provides for a smaller cross section to deter rain from entering the system. **Additional cones available in 1" or 2" reduction in diameter. *Available in 316L Stainless Steel***

SIZE	ORDER #	STOCK #	A	B	C
5" x 4"	FSCN0504	810003244	6 3/8"	4"	5"
12" x 10"	FSCN1210	810003496	6 3/8"	10"	12"
14" x 12"	FSCN1412	810003535	6 3/8"	12"	14"
16" x 14"	FSCN1614	810003570	6 3/8"	14"	16"

Storm Collar

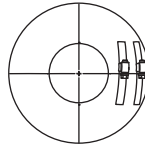

Use to create a weather tight seal between the pipe and flashing.

SIZE	ORDER #	STOCK #	SIZE	ORDER #	STOCK #
3"	FSC3	810003132	9"	FSC9	810003419
4"	FSC4	810003188	10"	FSC10	810003460
5"	FSC5	810003239	12"	FSC12	810003501
6"	FSC6	810003293	14"	FSC14	810003538
7"	FSC7	810003336	16"	FSC16	810003572
8"	FSC8	810003381			

Fixed Blade Damper

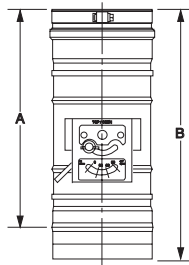

Use to ensure optimum pressures through an appliance. The Damper will aid in the proper operation and efficiency of the appliance by preventing higher than desired draft readings.

SIZE	ORDER #	STOCK #	A	B
6"	FSFBD06	810009495	13 1/2"	15 1/2"
8"	FSFBD08	810009497	13 1/2"	15 1/2"
10"	FSFBD10	810009499	13 1/2"	15 1/2"
12"	FSFBD12	810009500	13 1/2"	15 1/2"
14"	FSFBD14	810009501	18 1/2"	20 1/2"
16"	FSFBD16	810009502	18 1/2"	20 1/2"

Variable Pitch Roof Jack

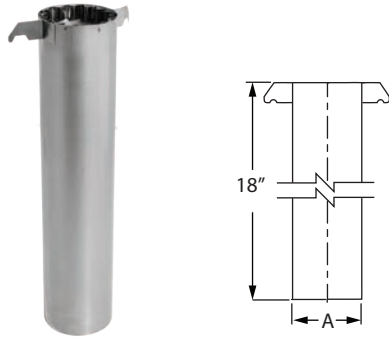

Use as a heat shield within the flashing. Maintains center-line and clearance to combustibles.

SIZE	ORDER #	STOCK #	A	SIZE	ORDER #	STOCK #	A
3"	FSVRJ3	810003133	4"	9"	FSVRJ9	810003420	10"
4"	FSVRJ4	810003189	5"	10"	FSVRJ10	810003461	11"
5"	FSVRJ5	810003240	6"	12"	FSVRJ12	810003502	13"
6"	FSVRJ6	810003294	7"	14"	FSVRJ14	810003539	15"
7"	FSVRJ7	810003337	8"	16"	FSVRJ16	810003573	17"
8"	FSVRJ8	810003382	9"				

Variable Pitch Roof Flashing

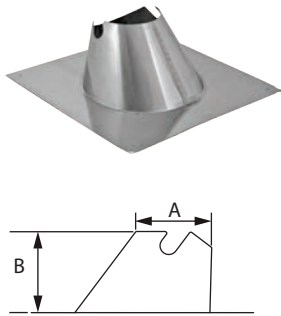

Use to create a weather-tight penetration where the vent pipe passes through the roof. Roof Jack and Storm Collar required. 3"-16"Ø accommodates flat to 9/12 roof pitch.

SIZE	ORDER #	STOCK #	A	B	SIZE	ORDER #	STOCK #	A	B
3"	FSVPF3	810003134	5"	7"	9"	FSVPF9	810003421	11"	7"
4"	FSVPF4	810003190	6"	7"	10"	FSVPF10	810003462	12"	7"
5"	FSVPF5	810003241	7"	7"	12"	FSVPF12	810003503	14"	7"
6"	FSVPF6	810003295	8"	7"	14"	FSVPF14	810003540	16"	7"
7"	FSVPF7	810003338	9"	7"	16"	FSVPF16	810003574	18"	7"
8"	FSVPF8	810003383	10"	7"					

Tall Cone Roof Jack



Use as a heat shield within the flashing. Maintains center-line and clearance to combustibles. Use with Tall Cone Flashings.

SIZE	ORDER #	STOCK #	A	SIZE	ORDER #	STOCK #	A
3"	FSRJ3	810005286	4"	9"	FSRJ9	810005290	10"
4"	FSRJ4	810005287	5"	10"	FSRJ10	810005291	11"
5"	FSRJ5	810005288	6"	12"	FSRJ12	810005292	13"
6"	FSRJ6	810005289	7"	14"	FSRJ14	810005293	15"
7"	FSRJ7	810007023	8"	16"	FSRJ16	810005294	17"
8"	FSRJ8	810005434	9"				

Tall Cone Flashing

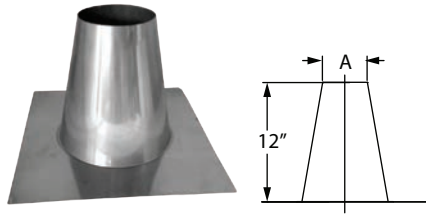

Use to create a weather-tight penetration where the vent passes through a flat roof. Roof Jack and Storm Collar required.

SIZE	ORDER #	STOCK #	A	SIZE	ORDER #	STOCK #	A
3"	FSAF3	810005257	4 1/3"	9"	FSAF9	810005263	10 1/3"
4"	FSAF4	810005258	5 1/3"	10"	FSAF10	810005264	11 1/3"
5"	FSAF5	810005259	6 1/3"	12"	FSAF12	810005269	13 1/3"
6"	FSAF6	810005260	7 1/3"	14"	FSAF14	810005270	15 1/3"
7"	FSAF7	810005261	8 1/3"	16"	FSAF16	810005271	17 1/3"
8"	FSAF8	810005262	9 1/3"				

Tapered Increaser



Use to increase vent diameter. Creates a smooth transition for an undistruptive flow. **Additional sizes available up to a maximum of 10" diameter change. *Available in 316L Stainless Steel***

SIZE	ORDER #	STOCK #	A	B	C
3" x 4"	FS0304TI	810003136	3"	4"	6 9/10"
4" x 5"	FS0405TI	810003191	4"	5"	6 9/10"

Eccentric Increaser

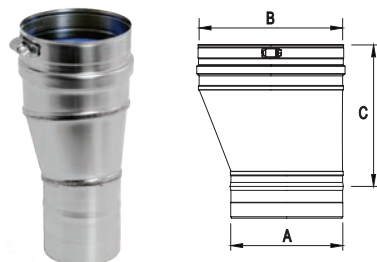

Use to transition to a larger diameter pipe. Prevents condensate puddling when used on horizontal runs. Aids in reducing formation of condensates. ***Available in 316L Stainless Steel***

SIZE	ORDER #	STOCK #	A	B	C
3" x 4"	FS0304EI	810003137	6"	8"	10 3/8"
4" x 5"	FS0405EI	810003193	4"	5"	7 3/25"
4" x 7"	FS0407EI	810014817	4"	7"	11 5/8"
5" x 9"	FS0509EI	810014819	5"	9"	14 3/8"
7" x 9"	FS0709EI	810014821	7"	9"	8 7/8"

Stepped Increaser

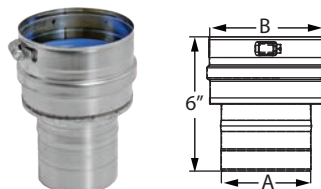

Use to increase vent diameter when space constraints are an issue. **More increasers available, contact customer service for information. *Available in 316L Stainless Steel***

SIZE	ORDER #	STOCK #	A	B
3" x 4"	FS34I	810003138	3"	4"
4" x 5"	FS45I	810003195	4"	5"

Tapered Reducer

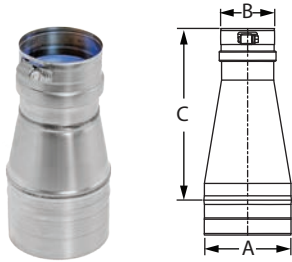

Use to reduce vent diameter. Creates a smooth transition for an undistruptive flow. **Additional sizes available, but reductions are limited to a maximum of 2" reduction in diameter.**

Available in 316L Stainless Steel

SIZE	ORDER #	STOCK #	A	B	C
4" x 3"	FS0403TR	810003192	4"	3"	6 1/10"
5" x 4"	FS0504TR	810003242	5"	4"	6 1/10"

Stepped Reducer

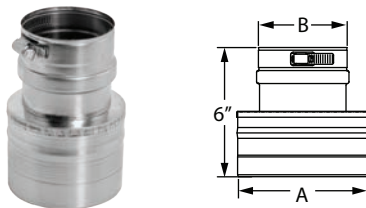

Use to reduce vent diameter when space constraints are an issue. **Available in custom size combinations.**

SIZE	ORDER #	STOCK #	A	B
4" x 3"	FS43R	810003194	4"	3"
5" x 4"	FS54R	810003243	5"	4"

Double-Wall Adapter

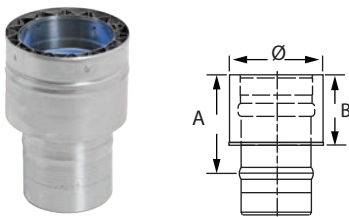

Use to transition from a single-wall pipe to double-wall pipe. To transition from double-wall to single-wall, please reference single-wall adapter available in double-wall FasNSeal section.

Available in 316L Stainless Steel

SIZE	ORDER #	STOCK #	A	B	SIZE	ORDER #	STOCK #	A	B
3"	FSA-SWDW3	810003139	4"	3"	9"	FSA-SWDW9	810003423	4"	3"
4"	FSA-SWDW4	810003197	4"	3"	10"	FSA-SWDW10	810003464	4"	3"
5"	FSA-SWDW5	810003246	4"	3"	12"	FSA-SWDW12	810003505	4"	3"
6"	FSA-SWDW6	810003298	4"	3"	14"	FSA-SWDW14	810003542	4"	3"
7"	FSA-SWDW7	810003340	4"	3"	16"	FSA-SWDW16	810003576	4"	3"
8"	FSA-SWDW8	810003385	4"	3"					

Vent Length with Support Plate

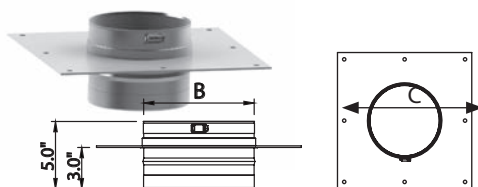

Use to provide an anchor point at the bottom of a vertical run or an additional way to brace a horizontal run.

SIZE	ORDER #	STOCK #	B	C
3"	FSSP3	810013336	3"	10"
4"	FSSP4	810013337	4"	11"
5"	FSSP5	810014720	5"	12"
6"	FSSP6	810012891	6"	13"
7"	FSSP7	810012892	7"	14"
8"	FSSP8	810012893	8"	15"

SIZE	ORDER #	STOCK #	B	C
9"	FSSP9	810012894	9"	16"
10"	FSSP10	810012895	10"	17"
12"	FSSP12	810012896	12"	19"
14"	FSSP14	810012897	14"	21"
16"	FSSP16	810012898	16"	23"

Standard Wall Mount Insulated Kit



Kit includes: Wall Thimble w/ Termination, Adjustable 90° Elbow, and Universal Appliance Adapter.

Use to vent wall mounted boilers or tankless water heaters. Terminates through-the-wall only. Available in 3", 4", and 5" vent diameters. Adjust vertically from 16 1/2" to 21" and horizontally from 8" to 12 1/2". 3" and 4" compatible with most gas-burning appliances. 5" compatible with tankless.

SIZE	ORDER #	STOCK #
3"	FSWMK103	810016554
4"	FSWMK104	810016555
5"	FSWMK105	810003072

Severe Weather Wall-Mount Insulated Kit



Kit includes: Wall Thimble w/ Termination Tee, Adjustable 90° Elbow, and Universal Appliance Adapter w/ Condensate Drain and Back Draft Preventer.

Use to vent wall mounted boilers or tankless water heaters. Use in areas of extreme wet and cold weather. Designed to prevent appliance freeze-up while maintaining an obstruction free exhaust. Available in 4" vent diameters, compatible with most 4" exhaust gas appliances. Add a 90° Elbow and Vent Length on the outside of the house to clear high snow lines.

SIZE	ORDER #	STOCK #
4"	FSSWWMK104	810016537

Variable Pitch Flashing Kit



Kit includes: Rain Cap, Storm Collar, Roof Jack, and Roof Flashing. (*VPKA Kit includes: a Universal Appliance Adapter w/ Condensate Drain).

Use to terminate through-the-roof vent systems. Kit accommodates flat to 9/12 roof pitch.

SIZE	ORDER #	STOCK #	SIZE	ORDER #	STOCK #
3"	FSVPK3	810003056	9"	FSVPK9	810003062
4"	FSVPK4	810003057	10"	FSVPK10	810003063
4"	FSVPKA4*	810003067	12"	FSVPK12	810003064
5"	FSVPK5	810003058	14"	FSVPK14	810003065
6"	FSVPK6	810003059	16"	FSVPK16	810003066
7"	FSVPK7	810003060			
8"	FSVPK8	810003061			

Insulated 90° Bird Screen Wall Mount Kit



Kit includes: 90° Bird Screen Termination, Wall Thimble, Adjustable 90° Elbow, and Universal Appliance Adapter.

Use to vent wall mounted boilers or tankless water heaters. 3" kit adjusts vertically from 14 1/2" to 19" and horizontally from 9" to 13 1/2". 4" kit adjusts vertically from 14" to 18 1/2" and horizontally from 9" to 13 1/2". Compatible with all Rheem gas appliances. 3" kit requires a FSA-RI-4.2 Adapter.

SIZE	ORDER #	STOCK #
3"	F5WMEKI03	810016538
4"	F5WMEKI04	810016539

Ceiling Mounted Insulated Heater Vent Kit



Kit includes Termination Tee, Wall Thimble w/Adjustable Vent Length, (2) 12" Vent Lengths, and Universal Unit Heater Adapter.

NOTE: F5CMK04CD includes Universal Appliance Adapter with Condensate Drain.

Kits Available in 316L Stainless Steel

Use to vent ceiling mounted heaters, through-the-wall termination only.

SIZE	ORDER #	STOCK #
3"	F5CMKI03	810016531
4"	F5CMKI04	810016533
4"	F5CMKI04CD	810016535

Universal Concentric Kit

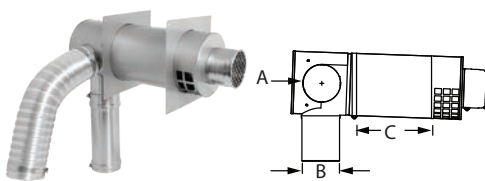

Use for through-the-wall termination with direct vent wall mounted gas appliances. Features an adjustable right- and left-hand air intake snout and accommodates wall thickness of 10" - 18". Check installation instructions for restrictions on horizontal termination, such as minimum distance from windows and doors.

SIZE	ORDER #	STOCK #	A	B	C
4"	F5EDVWMT04U	810003081	4"	4"	10" - 18"
5"	F5EDVWMT05U	810003084	5"	5"	10" - 18"

Wall Mount Concentric Kit

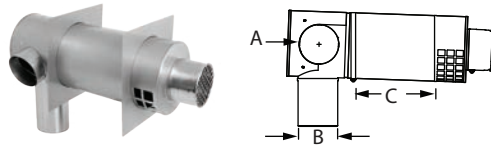

Use for through-the-wall termination with direct vent wall mounted gas appliances. Features a fixed right- or left-hand air intake snout and accommodates a maximum of 8" wall thickness. Check installation instructions for restrictions on horizontal termination, such as minimum distance from windows and doors.

SIZE	ORDER #	STOCK #	A	B	C
4"	FDVWMT0403RH	810003077	4"	3"	8" max.
4"	FDVWMT0403LH	810003078	4"	3"	8" max.
4"	FDVWMT04RH	810003079	4"	4"	8" max.
4"	FSEDVWMT04LH	810003080	4"	4"	8" max.

Remote Concentric Kit

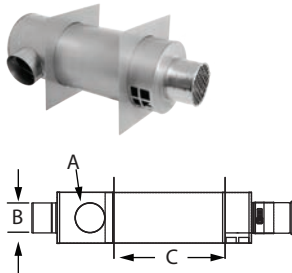

Use for through-the-wall termination with direct vent gas appliances located away from the wall. Check installation instructions for restrictions on horizontal termination, such as minimum distance from windows and doors.

Available in 316L Stainless Steel

SIZE	ORDER #	STOCK #	A	B	C
3"	FDVMT03	810003085	3"	3"	11" max.
4"	FDVWT04	810003083	4"	4"	11" max.
4"	FDVWT0403	810003082	3"	4"	11" max.

FasNSeal W2® - Double-Wall

Vent Length

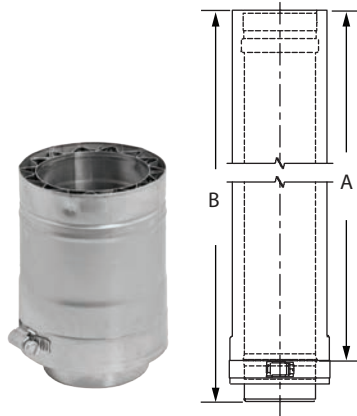

Used for venting special gas burning Categories II, III and IV appliances. To calculate O.D. add 1" to vent diameter.

Available in 316L Stainless Steel

Note: 48" lengths are only available in 316L Stainless Steel.

SIZE	ORDER #	STOCK #	A	B	SIZE	ORDER #	STOCK #	A	B
3"	W2-603	810003656	4"	6"	8"	W2-2408	810003763	22"	24"
3"	W2-1203	810003657	10"	12"	8"	W2-3608	810003764	34"	36"
3"	W2-1803	810003658	16"	18"	8"	W2-4808B	810016464	46"	48"
3"	W2-2403	810003659	22"	24"	9"	W2-609	810003783	4"	6"
3"	W2-3603	810003660	34"	36"	9"	W2-1209	810003784	10"	12"
4"	W2-604	810003677	4"	6"	9"	W2-1809	810003785	16"	18"
4"	W2-1204	810003678	10"	12"	9"	W2-2409	810003786	22"	24"
4"	W2-1804	810003679	16"	18"	9"	W2-3609	810003787	34"	36"
4"	W2-2404	810003680	22"	24"	9"	W2-4809B	810016465	46"	48"
4"	W2-3604	810003681	34"	36"	10"	W2-610	810003803	4"	6"
5"	W2-605	810003698	4"	6"	10"	W2-1210	810003804	10"	12"
5"	W2-1205	810003699	10"	12"	10"	W2-1810	810003805	16"	18"
5"	W2-1805	810003700	16"	18"	10"	W2-2410	810003806	22"	24"
5"	W2-2405	810003701	22"	24"	10"	W2-3610	810003807	34"	36"
5"	W2-3605	810003702	34"	36"	12"	W2-612	810003828	4"	6"
5"	W2-4805B	810016461	46"	48"	12"	W2-1212	810003829	10"	12"
6"	W2-606	810003719	4"	6"	12"	W2-1812	810003830	16"	18"
6"	W2-1206	810003720	10"	12"	12"	W2-2412	810003831	22"	24"
6"	W2-1806	810003721	16"	18"	12"	W2-3612	810003832	34"	36"
6"	W2-2406	810003722	22"	24"	14"	W2-614	810003853	4"	6"
6"	W2-3606	810003723	34"	36"	14"	W2-1214	810003854	10"	12"
6"	W2-4806B	810016462	46"	48"	14"	W2-1814	810003855	16"	18"
7"	W2-607	810003740	4"	6"	14"	W2-2414	810003856	22"	24"
7"	W2-1207	810003741	10"	12"	14"	W2-3614	810003857	34"	36"
7"	W2-1807	810003742	16"	18"	16"	W2-616	810003876	4"	6"
7"	W2-2407	810003743	22"	24"	16"	W2-1216	810003877	10"	12"
7"	W2-3607	810003744	34"	36"	16"	W2-1816	810003878	16"	18"
7"	W2-4807B	810016463	46"	48"	16"	W2-2416	810003879	22"	24"
8"	W2-608	810003760	4"	6"	16"	W2-3616	810003880	34"	36"
8"	W2-1208	810003761	10"	12"					
8"	W2-1808	810003762	16"	18"					

Adjustable Vent Length

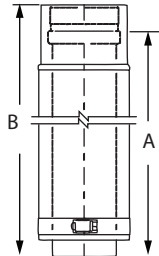

Use to add variable length to your straight length of FasNSeal pipe. Adds 2"-14" of length. Requires at least 4" overlap for a secure connection. ***Available in 316L Stainless Steel***

SIZE	ORDER #	STOCK #	A	B	SIZE	ORDER #	STOCK #	A	B
3"	W2-AVL3	810003661	2"-14"	18"	9"	W2-AVL9	810003788	2"-14"	18"
4"	W2-AVL4	810003682	2"-14"	18"	10"	W2-AVL10	810003808	2"-14"	18"
5"	W2-AVL5	810003703	2"-14"	18"	12"	W2-AVL12	810003833	2"-14"	18"
6"	W2-AVL6	810003724	2"-14"	18"	14"	W2-AVL14	810003858	2"-14"	18"
7"	W2-AVL7	810003745	2"-14"	18"	16"	W2-AVL16	810003881	2"-14"	18"
8"	W2-AVL8	810003765	2"-14"	18"					

Test Port

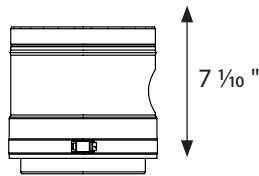

Use to test for proper appliance operation without penetrating the vent wall. Easy access to perform flue gas analysis. ***Available in 316L Stainless Steel***

SIZE	ORDER #	STOCK #	SIZE	ORDER #	STOCK #
3"	W2-TP03	810013163	9"	W2-TP09	810013169
4"	W2-TP04	810013164	10"	W2-TP10	810013170
5"	W2-TP05	810013165	12"	W2-TP12	810013171
6"	W2-TP06	810013166	14"	W2-TP14	810013172
7"	W2-TP07	810013167	16"	W2-TP16	810013173
8"	W2-TP08	810013168			

90° Elbow

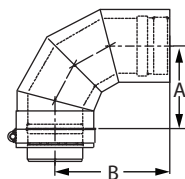

Use to go from horizontal to vertical runs or vertical to horizontal runs. Use to turn vent 90°. ***Available in 316L Stainless Steel***

SIZE	ORDER #	STOCK #	A	B	SIZE	ORDER #	STOCK #	A	B
3"	W2-9003	810003662	4"	6"	9"	W2-9009	810003789	7"	9"
4"	W2-9004	810003683	4 1/2"	6 1/4"	10"	W2-9010	810003809	7 1/2"	9 3/8"
5"	W2-9005	810003704	5"	6 3/4"	12"	W2-9012	810003834	8 1/2"	10 1/4"
6"	W2-9006	810003725	5 1/2"	7 1/2"	14"	W2-9014	810003859	9 1/2"	11 3/8"
7"	W2-9007	810003746	6 1/8"	7 7/8"	16"	W2-9016	810003882	11"	12 1/2"
8"	W2-9008	810003766	6 1/2"	8 1/4"					

88° Elbow

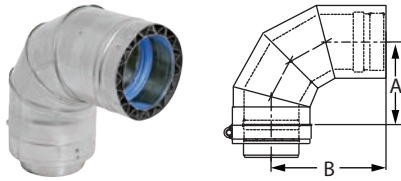

Use to transition from a vertical to a horizontal run. Facilitates a 2° pitch towards the condensate drain for good condensate management. ***Available in 316L Stainless Steel***

SIZE	ORDER #	STOCK #	A	B	SIZE	ORDER #	STOCK #	A	B
3"	W2-8803	810003663	4"	6"	12"	W2-8812	810003835	8 1/2"	10 1/4"
4"	W2-8804	810003684	4 1/2"	6 3/5"	14"	W2-8814	810003860	9 1/2"	11 3/8"
5"	W2-8805	810003705	5"	6 3/4"	16"	W2-8816	810003883	11"	12 1/2"
6"	W2-8806	810003726	5 1/2"	7 1/2"					
7"	W2-8807	810003747	6 1/8"	7 7/8"					
8"	W2-8808	810003767	6 1/2"	8 1/4"					
9"	W2-8809	810003790	7"	9"					
10"	W2-8810	810003810	7 1/2"	9 3/8"					

45° Elbow

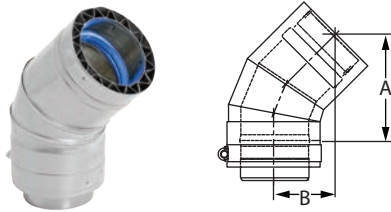

Offsets obstructions as needed. Allows for better condensate management and less back pressure.

Available in 316L Stainless Steel

SIZE	ORDER #	STOCK #	A	B	SIZE	ORDER #	STOCK #	A	B
3"	W2-4503	810003664	5 3/8"	3"	9"	W2-4509	810003791	7 1/2"	3 7/8"
4"	W2-4504	810003685	5 5/8"	3 1/8"	10"	W2-4510	810003811	7 7/8"	4"
5"	W2-4505	810003706	6"	3 1/4"	12"	W2-4512	810003836	8 1/2"	4 1/4"
6"	W2-4506	810003727	6 3/8"	3 3/8"	14"	W2-4514	810003861	9 1/4"	4 5/8"
7"	W2-4507	810003748	6 3/4"	3 1/2"	16"	W2-4516	810003884	10"	4 7/8"
8"	W2-4508	810003768	7 1/8"	3 5/8"					

30° Elbow

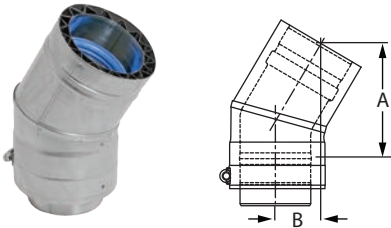

Offsets obstructions as needed. Allows for better condensate management and less back pressure.

Available in 316L Stainless Steel

SIZE	ORDER #	STOCK #	A	B	SIZE	ORDER #	STOCK #	A	B
3"	W2-3003	810003665	4 7/8"	1 7/8"	9"	W2-3009	810003792	7"	2 1/2"
4"	W2-3004	810003686	5 1/8"	1 7/8"	10"	W2-3010	810003812	6 1/2"	2 1/4"
5"	W2-3005	810003707	5 1/4"	2"	12"	W2-3012	810003837	7"	2 1/2"
6"	W2-3006	810003728	5 1/2"	2"	14"	W2-3014	810003862	7 1/2"	2 1/2"
7"	W2-3007	810003749	5 7/8"	2"	16"	W2-3016	810003885	8 1/8"	2 3/4"
8"	W2-3008	810003769	6 1/8"	2 1/8"					

15° Elbow

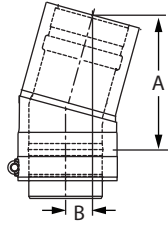

Offsets obstructions as needed. Allows for better condensate management and less back pressure.

Available in 316L Stainless Steel

SIZE	ORDER #	STOCK #	A	B	SIZE	ORDER #	STOCK #	A	B
3"	W2-1503	810003666	4 3/8"	7/8"	9"	W2-1509	810003793	5 1/4"	1"
4"	W2-1504	810003687	4 1/2"	1"	10"	W2-1510	810003813	5 1/4"	1"
5"	W2-1505	810003708	4 5/8"	7/8"	12"	W2-1512	810003838	5 1/2"	1"
6"	W2-1506	810003729	4 3/4"	7/8"	14"	W2-1514	810003863	5 3/4"	1"
7"	W2-1507	810003750	4 7/8"	1"	16"	W2-1516	810003886	6 1/8"	1"
8"	W2-1508	810003770	5 1/8"	1"					

Standard Tee

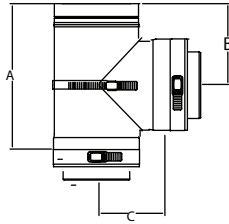

Use for a 90° offset, to combine connections from two or more appliances into a common vent or as a condensate management point when used in conjunction with drain fitting. All Standard Tees have completely welded inner walls.

Available in 316L Stainless Steel

SIZE	ORDER #	STOCK #	A	B	C	SIZE	ORDER #	STOCK #	A	B	C
3"	W2-T3	810003667	7 3/10"	4 1/2"	3"	9"	W2-T9	810003794	13 3/10"	7 3/10"	6"
4"	W2-T4	810003688	8 3/10"	4 4/5"	3 1/2"	10"	W2-T10	810003814	14 3/10"	7 4/5"	6 1/2"
5"	W2-T5	810003709	9 3/10"	5 3/10"	4"	12"	W2-T12	810003839	16 3/10"	9"	7"
6"	W2-T6	810003730	10 3/10"	5 4/5"	4 1/2"	14"	W2-T14	810003864	20 3/10"	11"	8 1/2"
7"	W2-T7	810003751	11 3/10"	6 3/10"	5"	16"	W2-T16	810003887	22 3/10"	12"	9 1/2"
8"	W2-T8	810003771	12 3/10"	6 4/5"	5 1/2"						

Wide Mouth Boot Tee

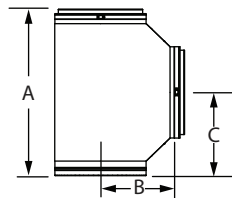

Use to transition from horizontal to vertical with improved flue gas flow with angled gradual transitions. Can also be used as a manifold connection to gang boilers into a common vent. Completely welded inner walls.

Available in 316L Stainless Steel

SIZE	ORDER #	STOCK #	A	B	C	SIZE	ORDER #	STOCK #	A	B	C
4"	W2-WBT4	810003689	15 3/4"	7"	6 9/10"	9"	W2-WBT9	810003795	20 3/4"	9 1/2"	9 4/10"
5"	W2-WBT5	810003710	16 3/4"	7 1/2"	7 4/10"	10"	W2-WBT10	810003815	21 3/4"	10"	9 9/10"
6"	W2-WBT6	810003731	17 3/4"	8"	7 9/10"	12"	W2-WBT12	810003840	23 3/4"	11"	10 9/10"
7"	W2-WBT7	810003752	18 3/4"	8 1/2"	8 4/10"	14"	W2-WBT14	810003865	25 3/4"	12"	11 9/10"
8"	W2-WBT8	810003772	19 3/4"	9"	8 9/10"	16"	W2-WBT16	810003888	27 3/4"	13"	12 9/10"

Double-Wall Wye



6" - 10" Diameters

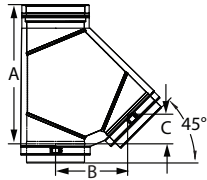

12" - 16" Diameters

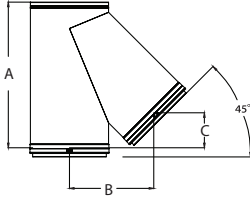

Use in place of any Duravent tee for a 45° angle instead of 90°; can be used as a manifold connection to gang multiple boilers into a common vent.

SIZE	ORDER #	STOCK #	A	B	C
6"	W2-WYE06	810004863	14 1/2"	7 1/2"	3 1/8"
7"	W2-WYE07	810007021	16 1/3"	8 3/5"	3 1/2"
8"	W2-WYE08	810004864	18"	9 7/10"	4"
9"	W2-WYE09	810007022	19 7/10"	10 7/10"	4 2/5"
10"	W2-WYE10	810004865	21 2/5"	11 13/16"	4 15/16"
12"	W2-WYE12	810004866	24 15/16"	14"	5 13/16"
14"	W2-WYE14	810004867	28 3/10"	16 1/8"	6 3/5"
16"	W2-WYE16	810009327	31 13/16"	18 1/5"	7 1/2"

Double-Wall Increaser Wye



6" - 10" Diameters

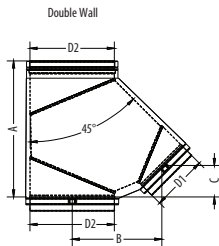

12" - 16" Diameters

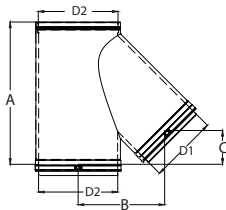

Use in place of any tee for a 45° angle instead of 90°. The branch has a smaller diameter, so it can be used to increase to a larger diameter as a manifold connection to gang multiple boilers into a common vent. Maximum diameter increase is 6". Available in custom size combinations.

SIZE	ORDER #	STOCK #	A	B	C
6" x 8"	W2-WYE0608	810012570	15 3/8"	9 1/4"	3 3/8"
6" x 10"	W2-WYE0610	810012571	16"	10 5/8"	3 5/8"
6" x 12"	W2-WYE0612	810012572	17 1/8"	12 1/2"	4"
8" x 10"	W2-WYE0810	810012573	18 3/4"	11 3/8"	4 3/8"
8" x 12"	W2-WYE0812	810012574	19 3/8"	12 3/4"	4 1/2"
8" x 14"	W2-WYE0814	810012575	20"	14 1/4"	4 5/8"
10" x 12"	W2-WYE1012	810012576	22 1/4"	13 1/2"	5 1/8"
10" x 14"	W2-WYE1014	810012577	22 7/8"	15"	5 3/8"
10" x 16"	W2-WYE1016	810012578	23 1/2"	16 3/8"	5 1/2"
12" x 14"	W2-WYE1214	810012579	25 5/8"	15 5/8"	6 1/8"

Tee Cap

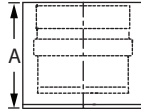

Use to cap Standard Tee, Branch Tee or Boot Tee. Remove Tee Cap to inspect the system; clean out debris.

Available in 316L Stainless Steel

SIZE	ORDER #	STOCK #	A	SIZE	ORDER #	STOCK #	A
3"	W2-TC3	810003668	3 1/2"	9"	W2-TC9	810003796	3 1/2"
4"	W2-TC4	810003690	3 1/2"	10"	W2-TC10	810003817	3 1/2"
5"	W2-TC5	810003711	3 1/2"	12"	W2-TC12	810003841	3 1/2"
6"	W2-TC6	810003732	3 1/2"	14"	W2-TC14	810003866	3 1/2"
7"	W2-TC7	810003753	3 1/2"	16"	W2-TC16	810003889	3 1/2"
8"	W2-TC8	810003774	3 1/2"				

Drain Fitting

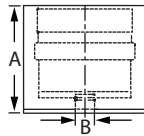

Use instead of Tee Cap to manage condensates at the bottom of a vertical run. For vent systems larger than 5", use an IPS Drain Fitting. ***Available in 316L Stainless Steel***

SIZE	ORDER #	STOCK #	A	B
3"	W2-DF3	810003670	3 1/2"	5/8"
4"	W2-DF4	810003692	3 1/2"	5/8"
5"	W2-DF5	810003713	3 1/2"	5/8"

IPS Drain Fitting

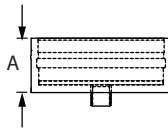

Use to connect iron drain pipe to flow acidic condensates to a neutralization tank before disposal. Uses 1" NPT thread.

Available in 316L Stainless Steel

SIZE	ORDER #	STOCK #	A	SIZE	ORDER #	STOCK #	A
3"	W2-IPSDf03	810003671	3 1/2"	9"	W2-IPSDf09	810003798	3 1/2"
4"	W2-IPSDf04	810003693	3 1/2"	10"	W2-IPSDf10	810003818	3 1/2"
5"	W2-IPSDf05	810003714	3 1/2"	12"	W2-IPSDf12	810003843	3 1/2"
6"	W2-IPSDf06	810003734	3 1/2"	14"	W2-IPSDf14	810003868	3 1/2"
7"	W2-IPSDf07	810003755	3 1/2"	16"	W2-IPSDf16	810003890	3 1/2"
8"	W2-IPSDf08	810003775	3 1/2"				

Insulated Wall Thimble w/ AVL

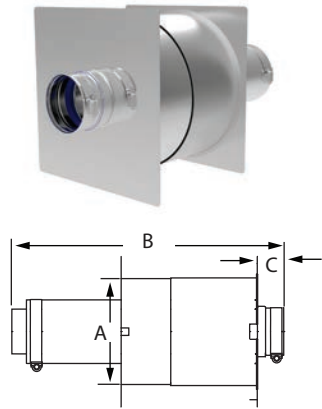

Use for through-the-wall termination. Fits between standard wall studs. 3"- 5" diameters accommodate wall thickness of 4 1/4" to 8 1/2". 6"- 16" diameters accommodate wall thickness of 5 3/4" to 11 1/2". AVL pipe allows for adjustability in length variance.

Available in 316L Stainless Steel

SIZE	ORDER #	STOCK #	A	B	C
3"	W2-WTI03	810016506	6"	18"	1 1/2"
4"	W2-WTI04	810016507	7"	18"	1 1/2"
5"	W2-WTI05	810016508	8"	18"	1 1/2"
6"	W2-WTI06	810016509	9"	18"	1 1/2"
7"	W2-WTI07	810016510	10"	18"	1 1/2"
8"	W2-WTI08	810016511	11"	18"	1 1/2"
9"	W2-WTI09	810016512	12"	18"	1 1/2"
10"	W2-WTI10	810016513	13"	18"	1 1/2"
12"	W2-WTI12	810016514	15"	18"	1 1/2"
14"	W2-WTI14	810016515	17"	18"	1 1/2"
16"	W2-WTI16	810016516	19"	18"	1 1/2"

Wall Thimble Sleeve

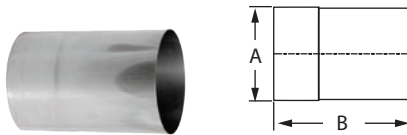

When installing FasNSeal W2 with this component use 1" larger diameter, (e.g., for a 10" vent system, use 11" size).

SIZE	ORDER #	STOCK #	A	B
3"	FSWTE3	810003126	6"	9"
4"	FSWTE4	810003180	7"	9"
5"	FSWTE5	810003233	8"	9"
6"	FSWTE6	810003286	9"	9"
7"	FSWTE7	810003330	10"	9"
8"	FSWTE8	810003373	11"	9"
9"	FSWTE9	810003412	12"	9"
10"	FSWTE10	810003450	13"	9"
12"	FSWTE12	810003491	15"	9"
14"	FSWTE14	810003531	17"	9"
16"	FSWTE16	810003566	19"	9"

Support Clamp



Use to support vertical and horizontal runs. Recommended every 10' in the vertical run. Use additional Support Clamps as needed. When installing FasNSeal W2 with this component use 1" larger diameter, (e.g., for a 10" vent system, use 11" size).

SIZE	ORDER #	STOCK #	A	SIZE	ORDER #	STOCK #	A
4"	FSCL4	810003182	1 1/2"	10"	FSCL10	810003452	1 1/2"
5"	FSCL5	810003235	1 1/2"	11"	FSCL11	810003825	1 1/2"
6"	FSCL6	810003288	1 1/2"	13"	FSCL13	810003849	1 1/2"
7"	FSCL7	810003332	1 1/2"	15"	FSCL15	810003873	1 1/2"
8"	FSCL8	810003375	1 1/2"				
9"	FSCL9	810003414	1 1/2"				

Vent Length with Support Plate

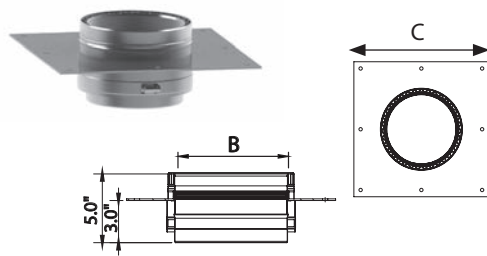

Use to provide an anchor point at the bottom of a vertical run or an additional way to brace a horizontal run.

SIZE	ORDER #	STOCK #	B	C	SIZE	ORDER #	STOCK #	B	C
3"	W2-SP3	810014721	4"	10"	9"	W2-SP9	810012902	10"	16"
4"	W2-SP4	810014722	5"	11"	10"	W2-SP10	810012903	11"	17"
5"	W2-SP5	810014723	6"	12"	12"	W2-SP12	810012904	13"	19"
6"	W2-SP6	810012899	7"	13"	14"	W2-SP14	810012905	15"	21"
7"	W2-SP7	810012900	8"	14"	16"	W2-SP16	810012906	17"	23"
8"	W2-SP8	810012901	9"	15"					

Rain Cap

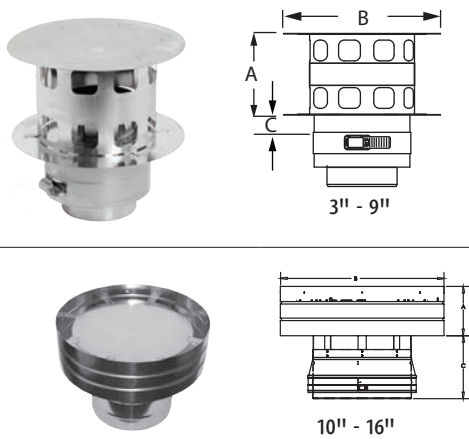

Use where pipe terminates above the roof line. When terminating larger than 12" vent diameter use a Termination Cone.

SIZE	ORDER #	STOCK #	A	B	C
3"	W2-RC3	810003673	3 1/2"	6 4/5"	1"
4"	W2-RC4	810003695	4 1/2"	8 9/10"	1"
5"	W2-RC5	810003716	5 4/5"	11 3/10"	1"
6"	W2-RC6	810003736	6 4/5"	13 1/2"	1"
7"	W2-RC7	810003757	7 4/5"	15 4/5"	1"
8"	W2-RC8	810003777	8 4/5"	18"	1"
9"	W2-RC9	810003800	10"	20 3/10"	1"
10"	W2-RC10	810012601	5"	16 3/4"	5 3/8"
12"	W2-RC12	810009880	6"	20"	5 11/16"
14"	W2-RC14	810009881	7"	23 1/2"	6"
16"	W2-RC16	810009882	8"	26 3/4"	6 1/3"

Termination Cone

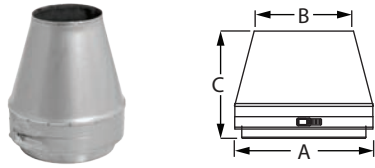

Use for vertical termination. Creates static back pressure to adjust harmonics. Venturi effect increases velocity of flue gases. Reduced opening provides for a smaller cross section to deter rain from entering the system. **Available in custom size combinations.**

SIZE	ORDER #	STOCK #	A	B	C
8" x 6"	W2-CN0806	810003778	8"	6"	6 3/8"
14" x 12"	W2-CN1412	810003870	14"	12"	6 3/8"

Stepped Inserter

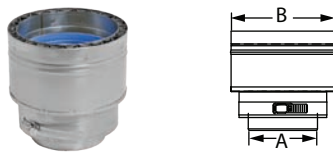

Use to increase vent diameter when space constraints are an issue. **Available in custom size combinations.**

Available in 316L Stainless Steel

SIZE	ORDER #	STOCK #	A	B
4" x 5"	W2-45I	810003696	4"	5"
8" x 9"	W2-89I	810003779	8"	9"

Fixed Blade Damper

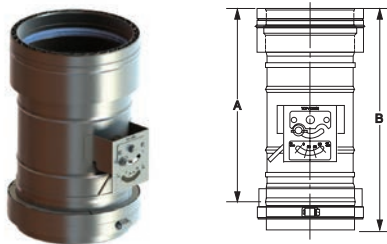

Use to ensure optimum pressures through an appliance. The Damper will aid in the proper operation and efficiency of the appliance by preventing higher than desired draft readings.

SIZE	ORDER #	STOCK #	A	B
6"	W2-FBD06	810009507	13 1/2"	15 1/2"
8"	W2-FBD08	810009509	13 1/2"	15 1/2"
10"	W2-FBD10	810009511	13 1/2"	15 1/2"
12"	W2-FBD12	810009512	13 1/2"	15 1/2"
14"	W2-FBD14	810009513	18 1/2"	20 1/2"
16"	W2-FBD16	810009514	18 1/2"	20 1/2"

Tapered Inserter

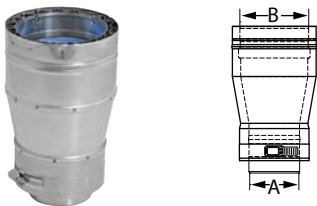

Use to increase vent diameter. Creates a smooth transition for an undisruptive flow. **Additional sizes available up to a maximum of 10" diameter change. *Available in 316L Stainless Steel***

SIZE	ORDER #	STOCK #	A	B
3" x 4"	W2-0304TI	810003674	3"	4"
3" x 6"	W2-0306TI	810003675	3"	6"

Eccentric Inserter

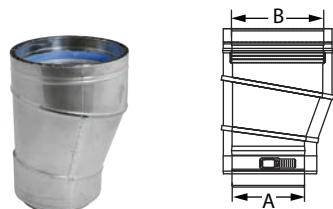

Use to transition to a larger diameter pipe. Adjusts the systems center point to offset from obstructions. Aids in reducing formation of condensates on horizontal runs. FasNSeal W2 has a 10" max change in diameter. **Additional sizes available up to a maximum of 10" diameter change.**

Available in 316L Stainless Steel

SIZE	ORDER #	STOCK #	A	B
8" x 10"	W2-0810E1	810003781	8"	10"

Stepped Reducer

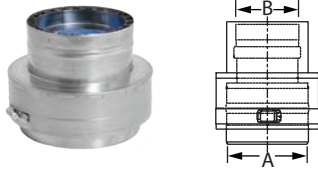

Use to reduce vent diameter when space constraints are an issue. Available in custom size combinations.

SIZE	ORDER #	STOCK #	A	B
7" x 5"	W2-75R	810003758	7"	5"
12" x 10"	W2-1210R	810003847	12"	10"

Tapered Reducer

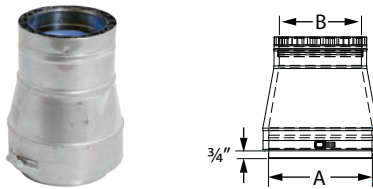

Use to reduce vent diameter. Creates a smooth transition for an undistruptive flow. FasNSeal W2 has a 10" max change in diameter. Additional sizes available up to a maximum of 10" diameter change. *Available in 316L Stainless Steel*

SIZE	ORDER #	STOCK #	A	B
8" x 7"	W2-0807TR	810003780	8"	7"
10" x 7"	W2-1007TR	810003822	10"	7"

Single-Wall Adapter

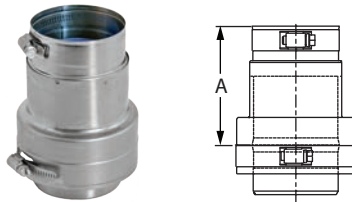

Use to transition from double-wall pipe to single-wall pipe. To transition from single-wall to double-wall, please reference double-wall adapter available in single-wall FasNSeal section. *Available in 316L Stainless Steel*

SIZE	ORDER #	STOCK #	A	SIZE	ORDER #	STOCK #	A
3"	FSA-DWSW3	810003676	4"	9"	FSA-DWSW9	810003801	4"
4"	FSA-DWSW4	810003697	4"	10"	FSA-DWSW10	810003821	4"
5"	FSA-DWSW5	810003717	4"	12"	FSA-DWSW12	810003846	4"
6"	FSA-DWSW6	810003737	4"	14"	FSA-DWSW14	810003871	4"
7"	FSA-DWSW7	810003759	4"	16"	FSA-DWSW16	810003893	4"
8"	FSA-DWSW8	810003782	4"				

Firestop/Flat Flashing

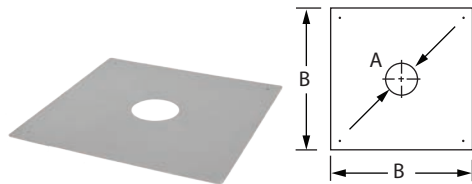

Use when penetrating floor levels. When installing double-wall with this component use 1" larger diameter, (e.g., for a 10" vent system, use 11" size).

SIZE	ORDER #	STOCK #	A	B	SIZE	ORDER #	STOCK #	A	B
4"	FSFS4	810003181	4 1/4"	15"	11"	FSFS11	810003823	11 3/5"	24"
5"	FSFS5	810003234	5 3/5"	17"	12"	FSFS12	810003492	12 3/5"	24"
6"	FSFS6	810003287	6 3/5"	17"	13"	FSFS13	810003848	13 3/5"	26"
7"	FSFS7	810003331	7 3/5"	19"	14"	FSFS14	810003532	14 3/5"	26"
8"	FSFS8	810003374	8 3/5"	19"	15"	FSFS15	810003872	15 3/5"	28"
9"	FSFS9	810003413	9 3/5"	22"	16"	FSFS16	810003567	16 3/5"	28"
10"	FSFS10	810003451	10 3/5"	22"					

Wall Bracket

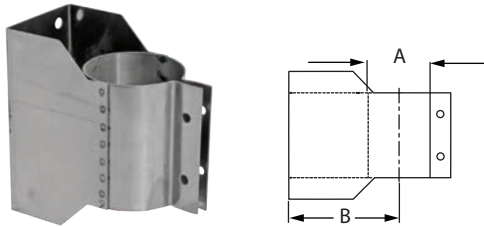

Use to support vent pipe or tee sections. Provides proper clearance to combustibles. When installing FasNSeal W2 with this component use 1" larger diameter, (e.g., for a 10" vent system, use 11" size).

SIZE	ORDER #	STOCK #	A	B	SIZE	ORDER #	STOCK #	A	B
4"	FSWB4	810003183	4"	4"	11"	FSWB11	810003826	11"	7 1/2"
5"	FSWB5	810003236	5"	4 1/2"	12"	FSWB12	810003494	12"	8"
6"	FSWB6	810003289	6"	5"	13"	FSWB13	810003850	13"	8 1/2"
7"	FSWB7	810003333	7"	5 1/2"	14"	FSWB14	810003534	14"	9"
8"	FSWB8	810003376	8"	6"	15"	FSWB15	810003874	15"	9 1/2"
9"	FSWB9	810003415	9"	6 1/2"	16"	FSWB16	810003569	16"	10"
10"	FSWB10	810003453	10"	7"					

23° Bird Screen

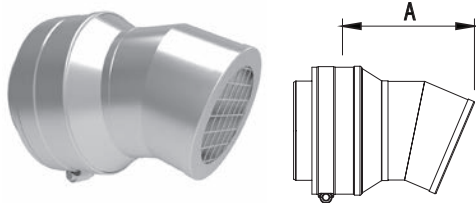

Use for 3" to 16" through-the-wall termination. Deters rain and other elements from entering the vent system. Check installation instructions for restrictions on horizontal terminations, such as minimum distance from windows and doors.

Available in 316L Stainless Steel

SIZE	ORDER #	STOCK #	A	SIZE	ORDER #	STOCK #	A
3"	W2-BS3	810016418	4 9/16"	9"	W2-BS9	810013205	10"
4"	W2-BS4	810016420	5 2/5"	10"	W2-BS10	810013206	11 4/5"
5"	W2-BS5	810013201	5 9/16"	12"	W2-BS12	810013207	13"
6"	W2-BS6	810013202	8"	14"	W2-BS14	810013208	19 2/5"
7"	W2-BS7	810013203	9 1/5"	16"	W2-BS16	810013209	19 1/5"
8"	W2-BS8	810013204	9 2/5"				

Termination Tee

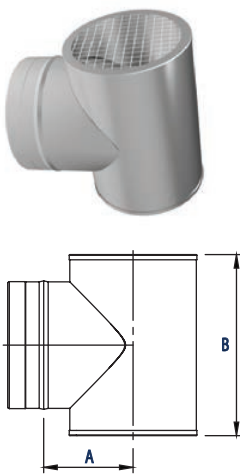

Use for standard and high-wind through-the-wall terminations. Check installation instructions for restrictions on horizontal terminations, such as minimum distance from windows and doors.

Available in 316L Stainless Steel

SIZE	ORDER #	STOCK #	A	B
3"	FSTT3	810003121	3"	6"
4"	FSTT4	810003175	3 1/2"	7"
5"	FSTT5	810003230	4"	8"
6"	FSTT6	810003282	4 1/2"	9"
7"	FSTT7	810014714	5"	10"
8"	FSTT8	810005266	5 1/2"	11"
9"	FSTT9	810014786	6"	12"
10"	FSTT10	810009492	6 1/2"	13"
12"	FSTT12	810014798	7 1/2"	15"
14"	FSTT14	810014800	8 1/2"	17"
16"	FSTT16	810014815	9 1/2"	19"

Termination Box

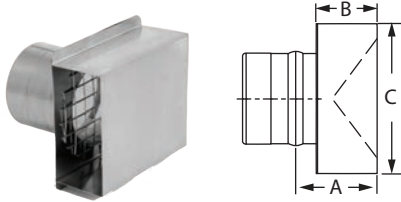

Use for horizontal through-the-wall terminations. Check installation instructions for restrictions on horizontal terminations, such as minimum distance from windows and doors.

Available in 316L Stainless Steel

SIZE	ORDER #	STOCK #	A	B	C
3"	FSTB3	810003122	2 3/16"	2"	5"
4"	FSTB4	810003176	2 3/16"	2"	6"

Storm Collar



Use to create a weather tight seal between the pipe and flashing. When installing FasNSeal W2 with this component use 1" larger diameter, (e.g., for an 10" vent system, use 11" size).

SIZE	ORDER #	STOCK #	SIZE	ORDER #	STOCK #
4"	FSC4	810003188	9"	FSC9	810003419
5"	FSC5	810003239	10"	FSC10	810003460
6"	FSC6	810003293	11"	FSC11	810003827
7"	FSC7	810003336	13"	FSC13	810003852
8"	FSC8	810003381	15"	FSC15	810003875

Variable Pitch Roof Flashing

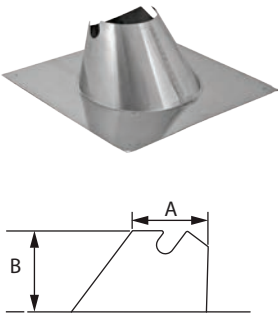

Use to create a weather-tight penetration where the vent pipe passes through the roof. Storm Collar required. When ordering Flashings for FasNSeal W2 product the flashing diameter and vent diameter are the same, i.e., W2-3610 requires a FSVPF10. Accommodates flat to 9/12 roof pitch.

SIZE	ORDER #	STOCK #	A	B	SIZE	ORDER #	STOCK #	A	B
4"	FSVPF4	810003190	6"	7"	9"	FSVPF9	810003421	11"	7"
5"	FSVPF5	810003241	7"	7"	10"	FSVPF10	810003462	12"	7"
6"	FSVPF6	810003295	8"	7"	12"	FSVPF12	810003503	14"	7"
7"	FSVPF7	810003338	9"	7"	14"	FSVPF14	810003540	16"	7"
8"	FSVPF8	810003383	10"	7"	16"	FSVPF16	810003574	18"	7"

Tall Cone Flashing

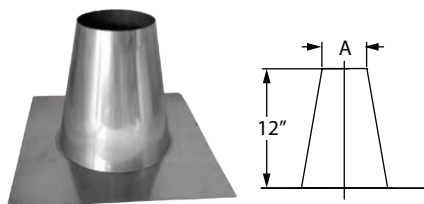

Use to create a weather-tight penetration where the vent pipe passes through a flat roof. Storm Collar required. When ordering Flashings for FasNSeal W2 product the flashing diameter and vent diameter are the same, i.e., W2-3610 requires a FSAF10.

SIZE	ORDER #	STOCK #	A	SIZE	ORDER #	STOCK #	A
3"	FSAF3	810005257	4 1/3"	9"	FSAF9	810005263	10 1/3"
4"	FSAF4	810005258	5 1/3"	10"	FSAF10	810005264	11 1/3"
5"	FSAF5	810005259	6 1/3"	12"	FSAF12	810005269	13 1/3"
6"	FSAF6	810005260	7 1/3"	14"	FSAF14	810005270	15 1/3"
7"	FSAF7	810005261	8 1/3"	16"	FSAF16	810005271	17 1/3"
8"	FSAF8	810005262	9 1/3"				

Appliances and Adapters

* Some Adapters are Available in 316L Stainless Steel. Contact Customer Service for more information *

Manufacturer	Model	Appliance Adapter	Termination Adapter
Aerco International	Benchmark 2.0 GWS, 3.0 LN	FSA-AE8	
	Benchmark 1000	FSA-AE6	
	KC-1000	FSA-AE6	
	Modulux Series	Standard Vent Pipe 4", 6"	
Ajax	Atlas GS Series	FSA-HFA6, 8	
	A250, A300	FSAAU12	
A.O. Smith	Burkay Genesis Series	FSA-HFA4 a, 5 a	
	Legend 2000 Series	FSA-HFA6 a, 7 a	
	ProStar Series	FSAAU4	
	GB/GW 400, 500	FSAAU6	
	GB/GW 1000	FSAAU10	
	GB/GW 1300, 1500	FSAAU12	
	GB/GW 1850, 2100	FSAAU14	
	GB/GW 2500	FSAAU16	
	GB/GW 300	FSAAU10	
	GB/GW 650, 750	FSAAU8	
	ATI 705-N	FSAAU4	
	ATIO 910-N	FSAAU5	
	Cyclone BTH-150	FSA-PVC3	
	Cyclone BTH-300, 400, 500	FSA-PVC4	
	VW-750	FSA-HFA6	
VW-1500	FSA-HFA7		
Aerco	Benchmark 1.5	FSA-AE6	
	Benchmark 750	FSA-AE6	
	Benchmark 1000	FSA-AE6	
	Benchmark 3000	FSA-AE8	
	Benchmark 6000	FSA-AE14	
	Esteem 399 (tankless)	FSA-ULT4	
Atlas	300	FS34I	
Beacon/Morris	BRU Series	FSAAU4	
	BTU Series	FSAAU4, 5, 6	
Bosch	Aquastar 125 FX	FSA-LMG04 a	
	Aquastar GHW-635-ES	Standard Vent Pipe 3"	
	Aquastar 250SX	Standard Vent Pipe 3"	
	Aquastar 240FX	FSAAU3	
	AquaStar 2400ES	FSAAU4	
	AquaStar 2700ES	FSAAU4	
	GWH 425EF	FSAAU4	
	660 EF	FSAAU3	
	SB625WS-160	FSA-200-8TP, W2-200-8TP	
	SB625WS-220	FSA-200-8TP, W2-200-8TP	
	SB625WS-290	FSA-250-10TP, W2-250-10TP	
	SB625WS-370	FSA-250-10TP, W2-250-10TP	
	SB625WS-480	FSA-300-12TP, W2-300-12TP	
	SB625WS-640	FSA-300-12TP, W2-300-12TP	

Manufacturer	Model	Appliance Adapter	Termination Adapter
Bosch	SB745WS-800	FSA-350-14TP, W2-350-14TP	
	SB745WS-1050	FSA-350-14TP, W2-350-14TP	
	SB745WS-1300	FSA-400-16TP, W2-400-16TP	
	SB745WS-1550	FSA-450-18TP, W2-450-18TP	
Bradford-White	EF Series	FSA-PVC3	
Bryan	AB Series	FSAAU	
Buderus	G115 Series	FSAAU4 or FSAAU5	
	G124X Series	FSAAU5, 6	
	G-515/ 7-12	FSAAU10	
	GA124 Series	FSAAU3	
	GA244/37, 44, 53	FSAAU3	
Buderus	GA244/62	FSAAU4	
	GB142 Series	FSAAU3	
	GB312/90 to GB312/160	FSA-158-6F	
	GB312/200 to GB312/280	FSA-197-8F	
	SB615 Series	FSA-SB7, 8, 10, 12	
Burnham	Independence PV	FSA-HFB3 b	FSA-PV3
	Minute Man II	FSA-HFB3 b	FSA-PV3
	Revolution	FSA-HFB3 b	FSA-PV3
	Revolution II	FSA-HFB3 b	FSA-PV3
	Series 2PV	FSA-HFB3 b	FSA-PV3
	Spirit	FSA-HFB3 b	FSA-PV3
	PVG/SCG Series	FSA-HFB3 b, 4 b	
	V11 Series	FSAAU8, 10, 12, 14, 16	
	V905	FSAAU8	
	ALP 150	FSA-PVC3	
	ALP 285	FSA-PVC4	
	ALP 399	FSA-PVC4	
	ALP 500	FSA-PVC4	
Camus Boiler	MicoFlame Series I	FSAAU3, 4, 5, 6	
	MicoFlame Series II	FSAAU8, 10, 12	
	MicoFlame Grande Series	FSAAU12, 14	
	DynaFlame Series	FSAAU6, 8, 10, 12, 14	
Camus	DynaMax	Standard Vent Pipe 6"	
	DynaForce 1000	FSAAU6 or 7	
	DynaForce 1600	FSAAU7	
	DynaForce 3000	FSAAU9	
Carel	Humidifier UG 180	FSAAU5	
Cleaver Brooks	MCF Series	FSA-MCF6, 8, 10, 12	
	FLX Series	FSA-FLX10, 12, 16	
	CFC 500	FSAAU6	
	CFC 1000	FSA-MCF8	
	CFC 1500	FSAAU10	
	CFC 1800	FSA-MCF12	
CFC 2500	FSAAU12		

Appliances and Adapters

* Some Adapters are Available in 316L Stainless Steel. Contact Customer Service for more information *

Manufacturer	Model	Appliance Adapter	Termination Adapter
Columbia	Patriot Series-Direct Vent	FSA-UTC4	
Crown Boiler Co.	Bali BWF-061, 095, 128, 162	Standard Vent Pipe 3" a	FSA-M3 a
	Bali BWF-195, 229	Standard Vent Pipe 4" a	FSA-M4 a
	Bimini BWC150, 225	Standard Vent Pipe 3" a, 4" a	FSA-M3, 4 a
	Bimini 300, 399, 425	Standard Vent Pipe 4" 5"	FSA-M3 a
	CWD 083	FSAAU3	
	BWF-095/ 128/ 162	Standard Vent Pipe 3"	
	BWF-195/ 229	Standard Vent Pipe 4"	
	Cabo CSC-050 thru 150	Standard Vent Pipe 3" a	
	Cabo CSC-175, 200	Standard Vent Pipe 3" a, 4" a	FSA-M3 a
	Cabo II CWD060-245	FSA-HFA3, 4	
	Dunkirk	XEB-2 thru XEB-5	FSAMETEK3
XEB-6 thru XEB-7		FSAMETEK3	
De Dietrich	GT334A, GT335A, GT336A	FSAAU7	
	GT337A, GT338A, GT339A	FSAAU8	
	GT430-8A to GT430-10A	FSAAU10	
	GT430-11A to GT430-14A	FSAAU12	
	GT-530- 22 thru -25	FSAAU18	
	Series 334,335, 336	FSAAU7	
	Series 337,338, 339	FSAAU8	
	Series 430-11, -12, -13,-14	FSAAU12	
	Series 430-8, -9, -10	FSAAU10	
	Series 310-5,-6, -7, -8, -9	FSAAU10	
	C-230 ECO	FSA-149-6F	
	C-130 ECO	FSA-250-10F	
	C-230 ECO	FSA-149-6F	
	C-310	FSA-250-10F	
	EcoTemp	40HI tankless	FSAAUUCD3
Fulton Boiler Works	EDR 750-1500	FSA-FULTEDR-6FNSF,	
	EDR 2000	FSA-FULTEDR-8FNSF	
	PHW 2000	FSA06T2.5	
	PHW 1400	FSA04T2.5	
	PulsePak PHW Series	FSA04T2.5, FSA06T2.5	
	Reliance RLN-750-1000	FSAAU6	
	Reliance RLN-1500-2000	FSAAU8	
	Reliance RLN-2500-3000	FSAAU10	
	Vantage VTG3000	FSAAU12	
	Vantage VTG 4000 / 6000	FSAAU14	
GasMaster	GMI Series	FSAAU4, 6, 8, 12	
Hamilton	EVO 299, 399, 599	Standard Vent Pipe 4" 5"	
Hayward Pool	H250 FD	FSA-HFA6	
	H300 FD, H350 FD, H400 FD	FSA-HFA8	

Manufacturer	Model	Appliance Adapter	Termination Adapter
HydroTherm	HI Series	FSAAU4	
	ID Series	FSAAU4	
	IHS Series	FSAAU4	
	KN-2	FSA-HFA3	
	KN-4	FSA-HFA4	
	KN-6	FSA-HFA5	
	KN-10 600, 1000, 2000	FSA-HFA4 a, 6 a, 8 a	
	KN-16	Standard Vent Pipe 6"	
	KN-20,30	Standard Vent Pipe 8"	
	Sabre FX Series	FSA-ELB3, 4	
	Jandy	Hi-E2 model 350	FSAAU4
Hi-E2 model 220		FSAAU3	
Pool heater 250		FSAAU6	
Pool heater 300		FSAAU7	
Laars	Pool heater 400	FSAAU8	
	Endurance EBP	FSA-B3 a	
	Endurance EDP	FSA-B3 a	
	Magna Therm 2000	FSAAU8	
	Magna Therm 3000	FSAAU10	
	Magna Therm 4000	FSAAU12	
	Mascot	FSA-80MM3	
	MightyTherm 2	FSAAU	
	Mini Combo id Series	FSAAU4	
	Mini Therm JVi	FSA-LMGD4 a	
	NeoTherm 285, 399, 500, 600	FSA-4PVC-4FNS	
	NeoTherm NT 750, 850	Standard Vent Pipe 6"	
	NeoTherm NT-1000	FSA-GIAN6-FNSF6	
	Pennant Series	FSAAU6, 8, 10, 12	
	Rheos 1200 - 2400	FSAAU6, 7, 10 a	
Rheos Plus 1200 - 2400	FSAAU6, 7, 10 a		
Summit 200, 250	FSA-3FNS-3PVCF		
Lennox	CMWB 2, 3, 4, 5, 6, 7	Standard Vent Pipe	
	CXE 2, 3, 4, 5, 6, 7	Standard Vent Pipe	
Lochinvar	AWN 286- 601	FSA-4PVC-4FNS	
	Copper Fin CBN	FSAAU6, 8, 10, 12, 14	
	Copper Fin II CHN	FSAAU6, 8, 10, 12, 14	
	Crest 500	Standard Vent Pipe 7"	
	Crest 2000	Standard Vent Pipe 8"	
	Crest 2500	Standard Vent Pipe 9"	
	Crest 3000	Standard Vent Pipe 10"	
	Crest 3500	Standard Vent Pipe 10"	
	Crest 4000	Standard Vent Pipe 12"	
	Crest 5000	Standard Vent Pipe 14"	

FasNSeal | Adapters Appliances and Adapters

* Some Adapters are Available in 316L Stainless Steel. Contact Customer Service for more information *

Manufacturer	Model	Appliance Adapter	Termination Adapter
Lochinvar	Efficiency+ EBN 100	FSA-PSC/DE3 a	
	Efficiency+ EBN 150, 200	FSAAU4	
	Efficiency+ EBN 250, 300	FSAAU5	
	ERN 252, 302, 402	FSAAU6	
	IWN 1500	FSAAU6	
	Knight 51-211	FSA-23803-FNS	
	Knight 55-85	FSA-KNWH55-85 (air intake FSELB9003BS)	FSB53/FSRC3
	Knight 110-285	FSA-KNWH110-285 (air intake FSELB9003BS)	FSB53/FSRC3
	Knight	FSA-PVC3, 4	
	Kight XL 399 thru 600	FSA-4PVC-4FNS	
	Kight XL 700 thru 800	FSA-6M-6PVC ELB	
	Intelli-Fin IBN 1500 thru 2000	FSA-200mm8/FSA150mm6	
	Power-Fin PBN 501 thru 2000	FSAAU7, 8, 9, 10, 12	
	Power-Fin PFN 501 thru 2000	FSAAU7, 8, 9, 10, 12	
	Shield 285 - 500	FSA-4PVC-4FNS	
	SYNC SBN 1000, 1300, 1500	Standard Vent Pipe 6"	
	Efficiency EWN 300	FSAAU6	
Modine	BDP	Standard Vent Pipe 3" a d	FSA-M3 a
	Model HDS30, 45, 60, 75	FSAAU3, 4	FSA-M3, 4 a
	PDP	Standard Vent Pipe 3" a d	FSA-M3 a
Navien	CC240, CC240A	FSA-4PVC-4FNS	
New Yorker	PVCG Series	FSA-HFB3 b	FSA-NYV3 a
Nordyne	FG6RA Series	FSAAU3, 4, 5	
	FG6RC-045	FSA-PVC3 a	
Nortec	GS Series 100 thru 600	FSAAU3, 4, 5, 6	
	GH Series 100 thru 400	FSAAU3, 4	
	N-0531S	FSA-APD3	
	N-0631S	FSAAU4	
Noritz	N-0751M	FSAAU4	
	N-0751M-DV	FSAAU4	
	N-0931M	FSAAU4	FSA-NSC4
	N-0931M-DV	FSAAU4	
	N-0931M ASME	FSAAU4	
	N-0931M-DV ASME	FSAAU4	FSA-NSC4
	NH-1501-DV ASME	FSAAU4	FSA-NSC4
	NH-2001-DV ASME	FSAAU4	
	N-1321M	FSAAU5	
	NC 380	FSAAU5	
	N 0531S	FSA-APD3	
	NR66	FSAAN03	
	NR-71	FSAAU4	
	NR 89SV	FSAAU4	

Manufacturer	Model	Appliance Adapter	Termination Adapter	
NTI	FTG 600, 800	6" FNS SW		
	FTG 1200, 1400, 2000, 2200, 2400	8" FNS SW		
NTI	FTV 110, 150, 190, 110C, 150C, 190C	3PPS-ADM-03FNSFC		
	LX 150, 200, 200WH	FSA-3PVC3-3FNSF		
	LX 300, 400, 500, 600, 300WH, 400WH, 500WH, 600WH	FSA-4PVCM-4FNSF		
	LX 700, 800, 700WH, 800WH	FSA-6PVCM-6FNSF		
	TFT 60, 110, 155, 175, 200, 201, 250, 285	FSA-3PVC3-3FNSF		
	TFT 154	FSA-3PVC3-3FNSF		
	TFT 300, 340, 399	FSA-4PVCM-4FNSF		
	TX 51, 81, 101, 151, 200, 151C, 200C	3PPS-ADM-03FNSFC		
	VM 110, 153, 110P, 153P	3PPS-ADM-03FNSFC		
	FTVN 085, 110, 150, 199, 110C, 150C, 199C	3PPS-ADM-03FNSFC (only for 3" appliance stub outs)		
	Paloma	N069M	FSAAU4	
		PH28RIFSN/P	FSAAU4	
		PH28CIFSN/P	FSAAU4	
PH20RIFSN/P		FSA-RI-4.2		
PTG42PVN/P		FSA-RI-4.2		
PTG-74 PVN	FSAAU4			
Patterson-Kelley	P-K Thermific Series	FSAAU10, 12		
	P-K Modu-Fire Series (except FD)	W2-AA10, 12		
	P-K Modu-Fire FD	FSAAU6, 8		
	P-K MACH c-300, 450, 900, 1050	FSA-PK4, 5, 8, FSA-HFA10		
	P-K MACH c-750	FSA-PKT6 or Standard Vent Pipe 6"		
	C1500 & C2000	FSA-250-10F		
C2500 - C4000	FSA-HFA10			
Peerless	Cast 92-4	FSA-HFA4		
	DE Series	FSA-PSC/DE3 a		
	PDE Series	FSA-PDE3 a		
	PSC Series	FSA-PSC/DE3 a		
	PSC II Series	FSA-HFA3		
	PF-210	FSA-3PVCM-3FNS		
	PF-399	FSA-4PVCM-4FNSF		
	PF850, PF-1000	Standard Vent Pipe 6"		
Pennco	FSB Series	FSAMETEK3		
Pentair	MiniMax NT, MasterTemp	std. 4" avl w/ RTV & stepped increaser		

Appliances and Adapters

* Some Adapters are Available in 316L Stainless Steel. Contact Customer Service for more information *

Manufacturer	Model	Appliance Adapter	Termination Adapter
PVI	Conquest 199 to 300	FSA-4PVC0-4FNSF	
	Conquest 399 to 800	FSA-6PVC0-6FNSF	
	Power VT Series	FSA-HFA4 a	
	Platinum 399	FSA-PVC4	
	1400N 250A-PV	FSA-PVC4	
	TurboPower 500N 25A-TP	FSAAU5	
	TurboPower 750N- 1500N	FSAAU6	
Quietside	QVM8 Series	FSAAU3	FSA-PV3
	DPW 199	FSA-PVC4	
	DPW 120A	FSA-PVC3	
Raypak	Advanced Design Boiler ADB-500	FSAAU6	
	ADB-750 thru 1501	FSAAU8, 10, 12	
	Hi Delta 122 thru 2342	FSAAU4, 5, 6, 8, 12, 14, 16	
	MVB 1003	FSAAU6	
	Xfyre 700A/850A	FSA-6PVC0-6FNSF	
	MVB 2003, 1753, 1503, 1253	FSAAU8	
	Pool heater CR-406A	FSAAU9	
	Pool heater CR-336A	FSAAU8	
	Pool heater CR-266A	FSAAU7	
	Pool heater CR-206A	FSAAU6	
	Pool heater P-514	FSAAU10	
Raypak	X-Therm WH-1505, 2005	FSAAU8	
	X-Therm WH-1005	FSAAU6	
	X-Therm H2005	FSAAU8	
	Xfyre 300, 400, 500	FSA-ULT4	
RBI	Fusion Series	FSA-HFA	
	Futera II Series	FSA-HFA	
	Futera III Series	FSA-HFA	
	Dominator Series	FSA-HFA	
	LCD Dominator Series	FSA-HFA	
Rheem/Ruud	RTG-42PVN (Pronto 4.2)	FSA-RI-4.2	
	RTG-74 (Pronto 7.4)	FSAAU4	
	RL-75i	FSAAU4	
Slantfin	Caravan Series	FSA-HFA3 a	
	Concept 21 Series	FSA-HFA3 a	FSA-NYV3 a
	Prodigy 21	FSA-HFA3 a	
	Victory VSPH Series	FSA-HFA3 a	
	Victory II Series	FSA-HFA3 a	
Smith	HB 28A	FSAAU18	
	Series 19A -5, -6	FSAAU8	
	Series 19A -7	FSAAU9	
	Series 19A -8, -12	FSAAU10	
	Cast Iron- 28A	FSAAU	

Manufacturer	Model	Appliance Adapter	Termination Adapter
Smith Cast Iron	GV100 Series	FSA-SMITH4	
	Lexington GS110 Series	FSA-ELB3, 4	
	GT 200	FSAAU3	
State Water Heater	Aurora GAX194	FSAAU14	
StayRite	Pool Heater	FSA-STARITE-4	
Takagi	TH-2S-DV	Standard Vent Pipe 4"	
	T-H1	FSAAU4	FSA-TTA4
	T-K1	FSAAU4	FSA-TTA4
	T-K2	FSAAU4	FSA-TTA4
	T-K3	FSAAU4	FSA-TTA4
	T-K1S	FSAAU4	FSA-TTA4
	T-K Jr.	FSAAU4	FSA-TTA4
	T-KD20	FSAAU4	FSA-TTA4
	T-M1	FSAAU4	FSA-TTA4
	T-M50	FSAAU5	FSA-TTA4
Thermo-Dynamics	Solaris	FSA-TS6	
	LMGD Series	FSA-LMGD4 a	FSA-LMGDTERM4 a
	CWL-GS Series	TBA	
Thermal Solutions	Evolution Series	FSA-HFA3 a, 4 a, 6 a, 8 a	
Triad	1600 (steam)	FSAAU8	
	900 (steam)	FSAAU8	
Triangle Tube	Delta Performance	FSA-TR3	
	Delta Performance Plus	FSA-TR3	
	Prestige Solo 250	FSA-ULT3	
Triangle Tube	Prestige Solo 399	FSA-ULT4	
	Prestige Solo 110	FSA-ULT3	
	Solo 250	FSA-ULT3	
	Solo 399	FSA-ULT4	
U.S. Boiler	ESC series	Standard Vent Pipe	
Utica	USC Series	Standard Vent Pipe a d	
	SVB Series	Standard Vent Pipe	
	DV-B Series	Standard Vent Pipe a d	
Vapac	GF Series	FSA-GF3	

a = High-temperature RTV silicone sealant is required.

b = Can also be vented with FSAVL3 (3") or FSAVL4 (4").

c = Additional Muffler adapters required.

d = Can use FSAAU in place of Standard Vent Length with silicone.

Appliances and Adapters

* Some Adapters are Available in 316L Stainless Steel. Contact Customer Service for more information *

Manufacturer	Model	Appliance Adapter	Termination Adapter
Viessmann	Vitocrossal 300 CT-3 Series	FSAAU8, 10, 12	
	Vitocrossal 300 Series CU3A 45, 57, 160, 199	FSA-110MM4	
	Vitocrossal 300 Series CU3A 26, 35, 94, 125	FSA-80MM3	
	Vitocrossal CM2 186-311	FSA-VCM2-08FNSF	
	Vitocrossal CM2 400-620	FSA-VCM2-10FNSF	
	Vitogas 50 ECV Series	Standard Vent Pipe 3" a	FSA-M3 a
	Vitogas 100 GS10 Series	FSAAU8, 9, 10	
	Vertomat VSB-37, 46, 57	TBA	
	Vitodens WB2 Series	FSA-80MM3 and FSA-110MM4	
	Vitorond	FSAAU12	
WB 100	FSA-80MM3		
Wai Wela	PH-16IFSN/P	FSA-RI-4.2	
	PH-20-RIFS/N	FSA-RI-4.2	
	PH-28RIFSN/P	FSAAU4	
Weben Jarco	Vision 3000 Series	FSA-HFA6, 8, 10 a	
	E-Finity	TBA	
Weil McLain	GV ST	FSA-WEIL-GV3	
	CGi Series	FSA-WM-CG13	
	CGs Series	FSA-WM-CG13	
	CGt Series	FSA-WM-CG13	
	GV GOLD Series 3	FSA-WEIL-GVTEE3	
	GV GOLD Series 4	FSA-WEIL-GVTEE3	
	GV90	FSA-ULT3	
	SlimFit SF 500/750 (Exhaust/Intake)	810007130	
	SlimFit SF 1000 (Exhaust)	FSA-SF-06FNSF-EX, FSA-SF-10FNSF-EX (CAT II 10")	
	SlimFit SF 1000 (Air)	FSA-SF-06FNSF-AIR (6"), FSA-SF-08FNSF-AIR (8")	
	SlimFit SF 1500, 2000 (Exhaust)	FSA-SF-08FNSF-EX, FSA-SF-10FNSF-EX (CAT II 10")	
	SlimFit SF 1500, 2000 (Air)	FSA-SF-08FNSF-AIR	
Ultra Series	FSA-ULT3, 4		
Williamson Thermoflo	GWI Series	FSA-WM-CG13	

Universal Appliance Adapter

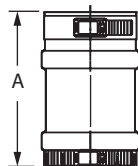

SIZE	ORDER #	STOCK #	A	SIZE	ORDER #	STOCK #	A
3"	FSAAU3	810003966	5 3/5"	9"	FSAAU9	810003982	5 3/5"
4"	FSAAU4	810003970	5 3/5"	10"	FSAAU10	810003984	5 3/5"
5"	FSAAU5	810003972	5 3/5"	12"	FSAAU12	810003987	5 3/5"
6"	FSAAU6	810003974	5 3/5"	14"	FSAAU14	810003990	5 3/5"
7"	FSAAU7	810003977	5 3/5"	16"	FSAAU16	810003992	5 3/5"
8"	FSAAU8	810003980	5 3/5"				

Universal Appliance Adapter w/ Test Port

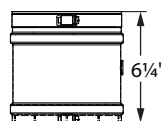

SIZE	ORDER #	STOCK #	SIZE	ORDER #	STOCK #
3"	FSAAUTP03	810003967	9"	FSAAUTP09	810003983
4"	FSAAUTP04	810003971	10"	FSAAUTP10	810003985
5"	FSAAUTP05	810003973	12"	FSAAUTP12	810003988
6"	FSAAUTP06	810003975	14"	FSAAUTP14	810003991
7"	FSAAUTP07	810003978	16"	FSAAUTP16	810003993
8"	FSAAUTP08	810003981			

Universal Appliance Adapter w/ Condensate Drain

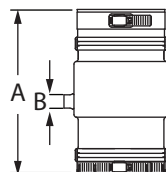

SIZE	ORDER #	STOCK #	A	B
3"	FSAAUCD03	810007011	7 7/10"	5/8"
4"	FSAAUCD04	810003968	7 7/10"	5/8"

Universal Appliance Adapter w/ Condensate Drain and Back Flow Preventer

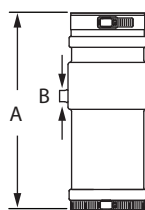

SIZE	ORDER #	STOCK #	A	B
4"	FSAAUCDLFP04	810003969	11"	5/8"

W2 Appliance Adapter

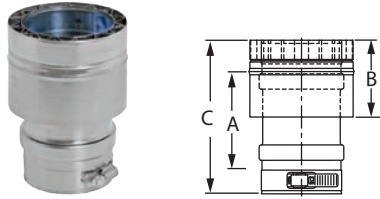

SIZE	ORDER #	STOCK #	A	B	C
3"	W2-AA3	810003994	4 4/5"	3"	6"
4"	W2-AA4	810003996	4 4/5"	3"	6"
5"	W2-AA5	810003998	4 4/5"	3"	6"
6"	W2-AA6	810004000	4 4/5"	3"	6"
7"	W2-AA7	810004002	4 4/5"	3"	6"
8"	W2-AA8	810004005	4 4/5"	3"	6"
9"	W2-AA9	810004006	4 4/5"	3"	6"
10"	W2-AA10	810004008	4 4/5"	3"	6"
12"	W2-AA12	810004010	4 4/5"	3"	6"
14"	W2-AA14	810004012	4 4/5"	3"	6"
16"	W2-AA16	810004014	4 4/5"	3"	6"

W2 Appliance Adapter w/ Test Port

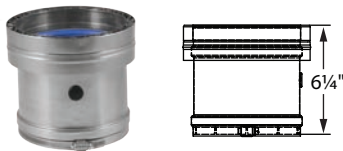

SIZE	ORDER #	STOCK #	SIZE	ORDER #	STOCK #
3"	W2-AATP03	810003995	9"	W2-AATP09	810004007
4"	W2-AATP04	810003997	10"	W2-AATP10	810004009
5"	W2-AATP05	810003999	12"	W2-AATP12	810004011
6"	W2-AATP06	810004001	14"	W2-AATP14	810004013
7"	W2-AATP07	810004003	16"	W2-AATP16	810004015
8"	W2-AATP08	810004005			

Metric Male Appliance Adapters

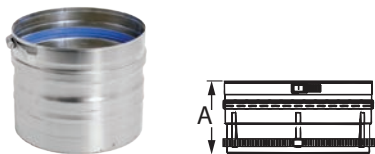

SIZE	ORDER #	STOCK #	A
149 mm	FSA-149-6F	810005577	6"
158 mm	FSA-158-6F	810004016	6"
197 mm	FSA-197-8F	810004017	6"
250 mm	FSA-250-10F	810004018	6"

De Dietrich GT Series Appliance Adapter



SIZE	ORDER #	STOCK #	A
7"	FSAAU7	810003977	5 3/5"
8"	FSAAU8	810003980	5 3/5"
10"	FSAAU10	810003984	5 3/5"
12"	FSAAU12	810003987	5 3/5"

PVC to FasNSeal Appliance Adapter



SIZE	ORDER #	STOCK #	A
2" to 3"	FSA-2PVCS-3FNSF	810009552	5 1/2"
3" to 3"	FSA-3PVCS-3FNSF	810005378	5 1/2"
4" to 4"	FSA-4PVCS-4FNSF	810004019	5 1/2"
4" to 6"	FSA-4PVCS-6FNSF	810009531	5 1/2"
4" to 7"	FSA-4PVCS-7FNSF	810013136	5 1/2"
6" to 4"	FSA-6PVCS-4FNSF	810012867	5 1/2"
6" to 6"	FSA-6PVCS-6FNSF	810016306	5 1/2"

6" Fulton EDR 750-1500 to 6" FasNSeal Appliance Adapter

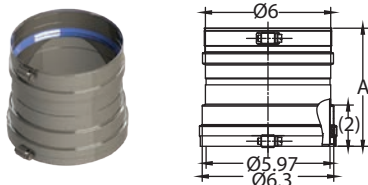

SIZE	ORDER #	STOCK #	A
6"	FSA-FULTEDR-6FNSF	810010020	5.9"

8" Fulton EDR 2000 to 8" FasNSeal Appliance Adapter

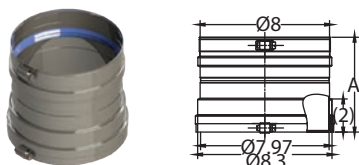

SIZE	ORDER #	STOCK #	A
8"	FSA-FULTEDR-8FNSF	810010021	5.9"

Fulton EDR to FasNSeal Appliance Adapter

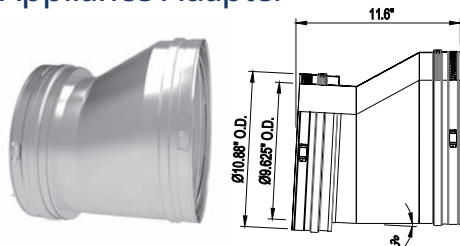

SIZE	ORDER #	STOCK #
12"	2-35-001856	810014279
14"	2-35-001857	810014480

Aerco International Appliance Adapter

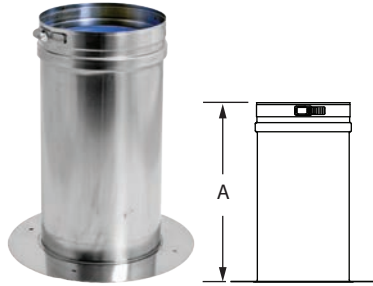

SIZE	ORDER #	STOCK #	A
6"	FSA-AE6	810004022	11 4/5"
8"	FSA-AE8	810004023	11 4/5"

Aerco Appliance Adapter



SIZE	ORDER #	STOCK #	A
12"	FSA-AE12	810004022	5 1/2"

W2 Aerco Appliance Adapter

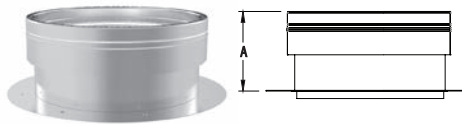

SIZE	ORDER #	STOCK #	A
12"	W2-AE12	810016424	5 1/2"

Laars Endurance Series Appliance Adapter

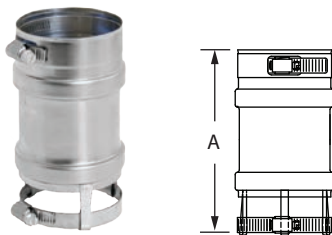

SIZE	ORDER #	STOCK #	A
3"	FSA-B3	810004024	4 4/5"
4"	FSA-B4	810004025	4 4/5"

Elbow Appliance Adapter

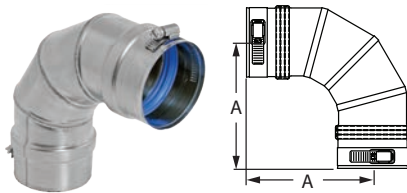

SIZE	ORDER #	STOCK #	A
3"	FSA-ELB3	810004026	6 1/2"
4"	FSA-ELB4	810004027	6 1/5"

Fulton Boiler Appliance Adapter

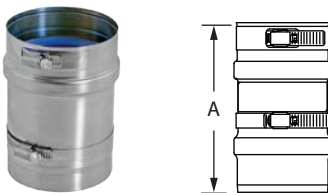

SIZE	ORDER #	STOCK #	A
4"	FSA-F4	810004028	4 9/16"
6"	FSA-F6	810004029	4 9/16"

Heatfab-To-FasNSeal Appliance Adapter



SIZE	ORDER #	STOCK #	A	SIZE	ORDER #	STOCK #	A
3"	FSA-HFA3	810004032	6"	7"	FSA-HFA7	810004036	6"
4"	FSA-HFA4	810004033	6"	8"	FSA-HFA8	810004037	6"
5"	FSA-HFA5	810004034	6"	9"	FSA-HFA9	810004038	6"
6"	FSA-HFA6	810004035	6"	10"	FSA-HFA10	810006988	6"

Burnham & New Yorker Appliance Adapter



SIZE	ORDER #	STOCK #	A
3"	FSA-HFB3	810004039	6"
4"	FSA-HFB4	810004040	6"

Bosch, Thermo-Dynamics & Laars Appliance Adapter

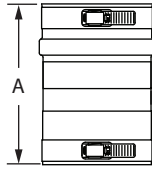

SIZE	ORDER #	STOCK #	A
4"	FSA-LMGD4	810004041	6"

Crown, Dunkirk & Modine Termination Appliance Adapter

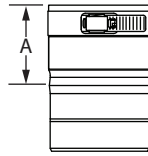

SIZE	ORDER #	STOCK #	A
3"	FSA-M3	810004042	2 1/2"
4"	FSA-M4	810004043	2 1/2"

Cleaver Brooks MCF Series Appliance Adapter

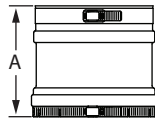

SIZE	ORDER #	STOCK #	A
6"	FSA-MCF6	810004044	6"
8"	FSA-MCF8	810004045	6"
10"	FSA-MCF10	810004046	6"
12"	FSA-MCF12	810004047	6"

Dunkirk XEB Series & Pennco FSB Series Appliance Adapter

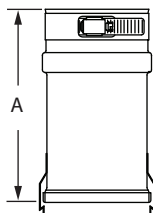

SIZE	ORDER #	STOCK #	A
3"	FSAMETEK3	810004048	6"

Fulton Tapered Appliance Adapter

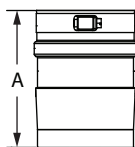

SIZE	ORDER #	STOCK #	A
4"	FSA04T2.5	810004030	5 3/4"
6"	FSA06T2.5	810004031	5 3/4"

Noritz NOM-DV Series Termination Appliance Adapter

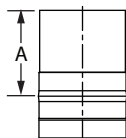

SIZE	ORDER #	STOCK #	A
4"	FSA-NSC4	810004049	4"

Slantfin Concept & New Yorker PVC Series Termination Appliance Adapter

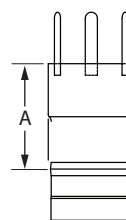

SIZE	ORDER #	STOCK #	A
3"	FSA-NYV3	810004050	4"

Peerless PDE Model Appliance Adapter

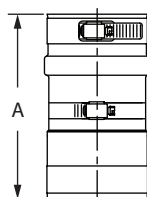

SIZE	ORDER #	STOCK #	A
6"	FSA-PDE3	810004051	6"

Patterson Kelly Mach Series Appliance Adapter

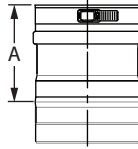

SIZE	ORDER #	STOCK #	A
4"	FSA-PK4	810004052	8 3/4"
5"	FSA-PK5	810004053	4 7/8"
8"	FSA-PK8	810004054	5 7/8"

Tapered Patterson Kelly Mach Series Appliance Adapter

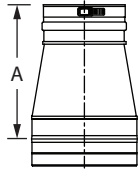

SIZE	ORDER #	STOCK #	A
6"	FSA-PKT6	810004055	8"

Peerless & Lochinvar Appliance Adapter

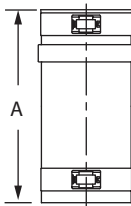

SIZE	ORDER #	STOCK #	A
3"	FSA-PSC/DE3	810004056	6"

Burnham & Quietside Termination Appliance Adapter

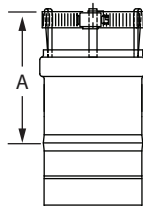

SIZE	ORDER #	STOCK #	A
3"	FSA-PV3	810004057	3"

PVC-To-FasNSeal Appliance Adapter

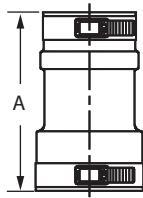

SIZE	ORDER #	STOCK #	A
3"	FSA-3PVC0-3FNSF	810005228	7 1/16"
4"	FSA-4PVC0-4FNSF	810005223	7 1/16"
6"	FSA-6PVC0-6FNSF	810005225	7 1/16"
8"	FSA-8PVC0-8FNSF	810005227	7 1/16"

Rheem/Ruud RTG & Paloma PTG/PH Series Appliance Adapter

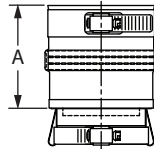

SIZE	ORDER #	STOCK #	A
3"	FSA-RI-4.2	810004058	3"

Buderus SB Series Appliance Adapter

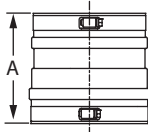

SIZE	ORDER #	STOCK #	A
7"	FSA-SB7	810004059	6"
8"	FSA-SB8	810004060	6"
10"	FSA-SB10	810004061	6"
12"	FSA-SB12	810004062	6"
14"	FSA-SB14	810004063	6"

Smith GV-100 Appliance Adapter

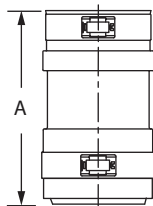

SIZE	ORDER #	STOCK #	A
4"	FSA-SMITH4	810004064	18"

Triangle Delta Series Appliance Adapter

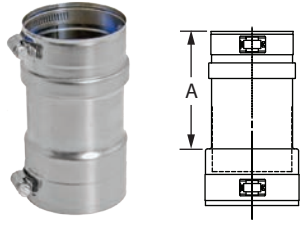

SIZE	ORDER #	STOCK #	A
3"	FSA-TR3	810004065	4"

Thermal Solutions Appliance Adapter



SIZE	ORDER #	STOCK #	A
6"	FSA-TS6	810004066	4 1/4"

Takagi TK-TV Series Termination Appliance Adapter



SIZE	ORDER #	STOCK #	A
4"	FSA-TTA4	810004067	3"

Weil McLain Ultra Series Appliance Adapter

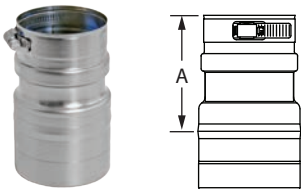

SIZE	ORDER #	STOCK #	A
3"	FSA-ULT3	810004068	3 3/5"
4"	FSA-ULT4	810004069	3 3/5"

Columbia LVGD Series Appliance Adapter

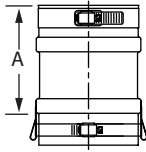

SIZE	ORDER #	STOCK #	A
3"	FSA-UTC3	810004073	4 1/2"
4"	FSA-UTC4	810004074	4 1/2"

Viessmann Vitoden Series Appliance Adapter

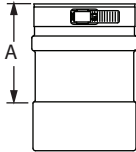

SIZE	ORDER #	STOCK #	A
3"	FSA-V3	810004075	3"
4"	FSA-V4	810004076	3"

Weil McLain GV Model Appliance Adapter

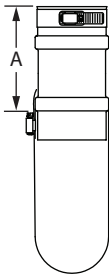

SIZE	ORDER #	STOCK #	A
3"	FSA-WEIL-GV3	810004070	4 1/2"

Weil McLain Tee Appliance Adapter

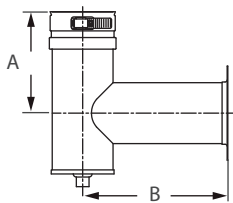

SIZE	ORDER #	STOCK #	A	B
3"	FSA-WEIL-GVTEE3	810004071	5"	7 3/10"

Weil McLain CG Series & Williamson Thermoflow GWI Series Appliance Adapter

SIZE	ORDER #	STOCK #	A
3"	FSA-WM-CG3	810004072	3"

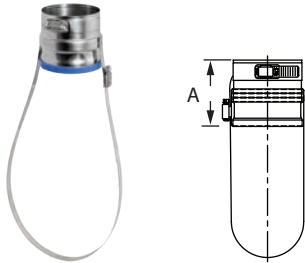

Fulton Muffler Inlet Muffler

SIZE	ORDER #	STOCK #	A
4"	FSAAM4	810004077	5 9/16"
6"	FSAAM6	810004078	5 9/16"

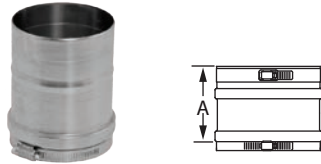

Female-To-Male Jeremias Muffler

SIZE	ORDER #	STOCK #	A
7"	FSA-180F-7M	810004079	5 1/2"



Male-To-Female Jeremias Muffler

SIZE	ORDER #	STOCK #	A
7"	FSA-7F-180M	810004080	5 1/2"



Terms & Condition of Sale

1. **PRICES:** All prices and designs are subject to change without notice.
2. **CREDIT:** All sales are subject to credit approval.
3. **SALES TAX:** All sales are taxable unless buyer provides valid resale documentation prior to shipment. Buyer is responsible for all sales and use taxes.
4. **BROKEN CARTON CHARGES:** Broken carton orders are subject to broken carton charges. Broken carton charges are 25% of list price per stock #.
5. **PALLET CHARGES:** All palletized, stretch-wrapped orders are an additional \$5 per pallet.
6. **UPS:** All UPS orders are subject to \$10 handling charge.
7. **TERMS:** Unless otherwise specified, our payment terms are net 30, F.O.B. shipping point.
8. **LATE CHARGES:** Delinquent accounts are subject to 1 ½% per month finance charge.
9. **MULTIPLE SHIPMENTS:** Orders may be fulfilled in separate shipments. Each shipment will be accompanied by a separate invoice and each invoice carries its own terms of payment.
10. **ALL SALES ARE FINAL:** All sales are final, and product cannot be returned for credit.
11. **DELAYS:** Duravent is not responsible for delays caused by our freight providers.
12. **REFUSAL OF DELIVERY:** Refused shipments, without cause, will result in additional charges, including freight, restocking and recartoning.
13. **SHORTAGES:** All claims for shortages and damages must be made within 48 hours.
14. **DAMAGE:** All visible damage on delivery is to be noted on the Bill of Lading before signing for delivery with driver. If shipment was freight collect, please file damage claim directly with the carrier. If shipment was freight Prepaid, please contact Duravent Customer Service 800-835-4429 as soon as possible for assistance with freight claim. Any evidence of damage to the carton is cause for immediate inspection of the goods. Damaged goods must be retained by the customer until credit is approved. All claims for damages must be accompanied by proof (e.g., digital photo) and is subject to approval by Duravent.
15. **DEFECTS:** All claims for manufacturing defects must be accompanied by proof (e.g., digital photo) and is subject to approval by Duravent.
16. **INDEMNITY:** Duravent does not permit modifications to products or changes to installation instructions. Customers modifying products or installation procedures shall, regardless of specific instructions to the user, indemnify, defend, and hold harmless Duravent for any and all claimed losses or damages occasioned in whole or in part by special order or modified products and procedures.
17. **RESALE OVER THE INTERNET:** Resale of product over the internet is subject to the terms of our "Internet Sales Policy" and warranty. A copy of this policy can be obtained from Customer Service at 1-800-835-4429.

Duravent Limited Lifetime Warranty

Duravent, Inc. (“Duravent”) provides this limited lifetime warranty for all of its products with the exception of Ventinox® (lifetime), and PolyPro® (ten years). Subject to the limitations set forth below, Duravent warrants that its products will be free from defects in material or manufacturing, if properly installed, maintained and used. Duravent products are fully warranted if installed only by a professional installer. This Warranty is transferable from the original homeowner to the buyer of the home. This warranty does not cover normal wear and tear, smoke damage or damage caused by chimney fires, acts of God, or any product that was: (1) purchased other than from an authorized Duravent dealer, retailer or distributor; (2) modified or altered; (3) improperly serviced, inspected or cleaned; or (4) subject to negligence or any use not in accordance with the installation instructions included with the product as determined by Duravent. Installation instructions are available online at www.Duravent.com under Support/Literature and through our Customer Service Department 800-835-4429 or customerservice@Duravent.com. This limited lifetime warranty applies only to parts manufactured by Duravent.

Duravent provides the following warranties for its products: One Hundred Percent (100%) MSRP 15 years from the date of purchase, and Fifty Percent (50%) thereafter, except for the following limitations on: all Termination Caps and DuraBlack® are warranted at One Hundred Percent (100%) for five years.

All warranty obligations of Duravent shall be limited to repair or replacement of the defective product pursuant to the terms and conditions applicable to each product line. These remedies shall constitute Duravent’s sole obligation and sole remedy under this warranty. This warranty provides no cash surrender value. The terms and conditions of this warranty may not be modified, altered or waived by any action, inaction or representation, whether oral or in writing, except upon the express, written authority of an executive officer of Duravent.

Corn, bio-fuels, driftwood or other wood containing salt, preservative-treated lumber, plastic and household trash or garbage, or wood pellets containing such materials must not be burned in the appliance or fireplace. In case of a chimney fire, the chimney must be inspected and approved by a certified Chimney Sweep before reuse. After each annual inspection, maintenance, and cleaning, the certified Chimney Sweep must fill out and date the appropriate section of the warranty card provided with the chimney liner.

LIMITATIONS ON INTERNET SALES: Notwithstanding any other terms or conditions of this Limited Lifetime Warranty, Duravent provides no warranty for the following specific products if such products are not installed by a qualified professional installer: DuraTech®, DuraTech® DTC, DuraPlus HTC®, DuraTech® Premium, DuraChimney® II, DuraPlus Canada 2, PelletVent Pro®, DirectVent Pro®,

FasNSeal®, FasNSeal® W2, FasNSeal® Flex, and PolyPro®, and Duravent’s relining products including DuraLiner®, DuraFlex® (SW, Pro, 316, 304), and Ventinox®. For purposes of this warranty, a trained professional installer is defined as one of the following: licensed contractors with prior chimney installation experience, CSIA Certified Chimney Sweeps, NFI Certified Specialists, or WETT Certified Professionals.

Duravent must be notified and given the opportunity to inspect defective product prior to replacement under the terms of this limited lifetime warranty. All warranty claims must be submitted with proof of purchase. Labor and installation costs are not covered under this warranty. To obtain warranty service contact: Duravent Warranty Service, 877 Cotting Ct., Vacaville CA 95688, or call 800-835-4429.

WHERE LAWFUL, DURAVENT DISCLAIMS ALL OTHER WARRANTIES, INCLUDING BUT NOT LIMITED TO IMPLIED WARRANTIES OF MERCHANTABILITY AND FITNESS FOR A PARTICULAR PURPOSE. IN NO EVENT WILL Duravent BE LIABLE FOR INCIDENTAL, CONSEQUENTIAL, PUNITIVE OR SPECIAL DAMAGES OR DIRECT OR INDIRECT LOSS OF ANY KIND, INCLUDING BUT NOT LIMITED TO PROPERTY DAMAGE AND PERSONAL INJURY. DURAVENT’S ENTIRE LIABILITY IS LIMITED TO THE PURCHASE PRICE OF THIS PRODUCT. SOME STATES DO NOT ALLOW LIMITATIONS ON IMPLIED WARRANTIES, OR THE EXCLUSION OR LIMITATION OF INCIDENTAL OR CONSEQUENTIAL DAMAGES, SO THE ABOVE LIMITATIONS AND EXCLUSIONS MAY NOT APPLY TO YOU. THIS LIMITED WARRANTY GIVES YOU SPECIFIC LEGAL RIGHTS, AND YOU MAY ALSO HAVE OTHER RIGHTS THAT VARY FROM STATE TO STATE.

For the most up-to-date installation instructions, see www.Duravent.com

REV 05.03.18

Manufactured in Vacaville CA and Albany NY



BUILD FOR THE FUTURE

Customer Service and Support:

Airmate (USA).....	800.992.8368
Airmate (CAN).....	888.735.5475
Ameriflow.....	800.252.8467
Amerivent (Retail).....	800.252.8467
Amerivent (Wholesale).....	800.423.4270
Amerivent (Support).....	800.748.0392
AMPCO (USA).....	800.669.3269
AMPCO (CAN).....	888.735.5475
Duravent.....	800.835.4429
Hart & Cooley.....	800.433.6341
Hart & Cooley (Support).....	800.748.0392
Heatfab (USA).....	800.772.0739
Heatfab (CAN).....	800.848.2149
Lima.....	800.423.4270
Milcor.....	800.774.5240
Portals Plus.....	800.774.5240
RPS.....	800.624.8642
Security Chimney (USA).....	800.361.4909
Security Chimney (CAN).....	800.667.3387
Selkirk (USA).....	800.848.2149
Selkirk (CAN).....	888.735.5475
Selkirk (Support).....	800.748.0392

Manufacturing & Distribution Centers:

CANADA	
Nobel, ON	Manufacturing
Laval, QC	Manufacturing
Prescott, ON	Distribution
USA	
Grand Rapids, MI	Center of Excellence
Dallas, TX	Distribution
Englewood, OH	Distribution
Huntsville, AL	Manufacturing & Distribution
Mira Loma, CA	Distribution
Nampa, ID	Manufacturing & Distribution
Turner Falls, MA	Manufacturing & Distribution
Vacaville, CA	Manufacturing
MEXICO	
Ojinaga, MX	Manufacturing
Mexicali, MX	Manufacturing

Corporate Headquarters:

Duravent Group
 28 W. Adams, Suite 1810
 Detroit, MI 48226
 Tel: 800.835.4429
 Email: info@duraventgroup.com
www.duraventgroup.com

duravent[™]

duravent[™]
GROUP

BUILD FOR THE FUTURE

www.duraventgroup.com

