

DuraVent Benefits for Owner & Contractor: Installation Savings, Life Cycle Savings, and Warranty

Why DuraVent for Your Next Project?

- Product features provide real benefits: reduce risks, costs, and save time.
- Ongoing product Voice of customer-driven product innovations.
- Industry's best and quickest design support.
- Company 100% dedicated to venting solutions.

How We Reduce Your Costs and Risks, And Save Time

- Product Features**
- Installation Savings = Greater Bottom Line
 - Installation Ease = Higher Quality Install

The DuraVent grease duct product offering provides many benefits, such as reduced labor costs, increased quality control, and unsurpassed durability.

We've improved the flanged system: Alignment or Centering Sleeve reduces installation costs and time with no leaks.

- Guides pieces together and provides backing for sealant.
- Stiffens large / heavy sections keeping flanges in perfect alignment for ease of v-band attachment (no leaks).
- Smaller diameter can be joined by one person as opposed to two (competitors have no alignment sleeve).
- Eliminates sealant from being accidentally wiped off flanges.

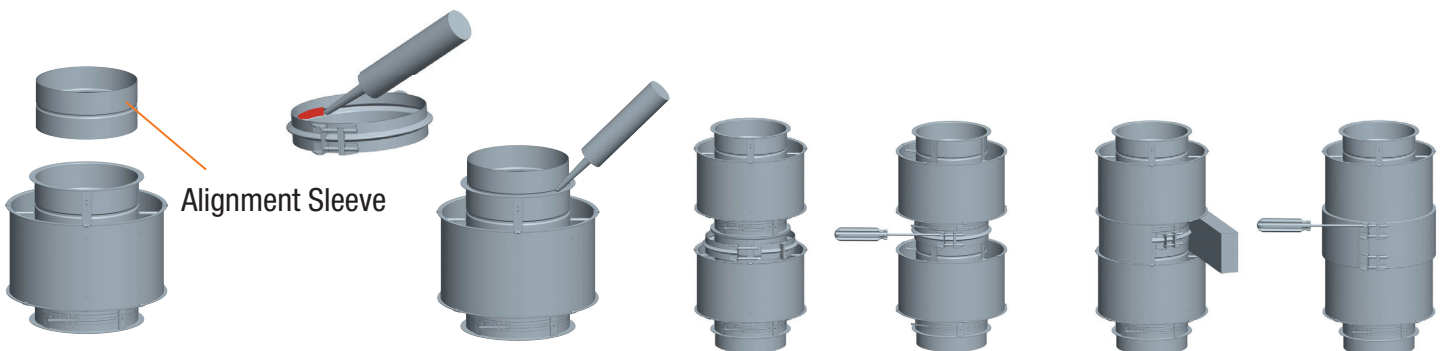

V-band:

- Captive nut and bolt.
- Eliminates loose nuts and bolts (including while on a ladder).
- Less aggravation.

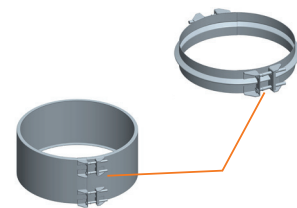

Factory-applied access door gasket

- Gasket factory-applied vs. competitor field installed (another thing for your installer to remember to do...and do correctly).
- Why buy prefab and then have to field-fabricate gasketing?

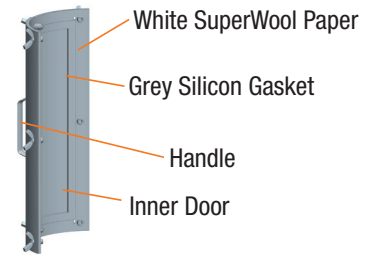

More space between outers

- 4 5/8" gap between outer walls vs. competitor gap of 2 1/2".
- Protects hands by allowing more room to work which leads to improved safety and less aggravation.

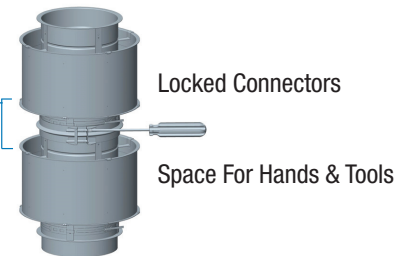

Life Cycle Savings -Maintenance Savings = Greater Bottom Line
-Maintenance Ease = Higher Quality Maintenance

Centering sleeve: durability

- Protects sealant from degradation and loss during cleaning.
- Especially cleaning with jet spray technology.

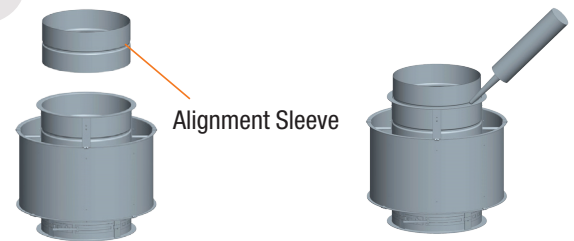

No-tool access tee cap

- Labor savings during maintenance. Easy, tool-less inspection.
- Doesn't strip out after repeated usages during cleaning and inspections.
- For every cleaning and inspection, competitors' inner bands must be taken off, old sealant must be removed from the bands, and new sealant must be applied correctly after inspection. Every time!

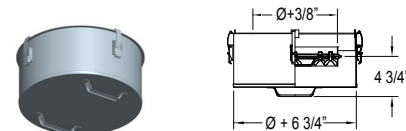

No-tool access door

- Labor savings during maintenance. Easy, tool-less inspection.
- Doesn't strip out after repeated usages during cleaning and inspections.

Galvalume outerwall option

- On applications where stainless aesthetics are not required, galvalume outer wall provides significant savings.
- Galvalume can also be painted to match architectural requirements, and in corrosive environments painting provides additional protection.

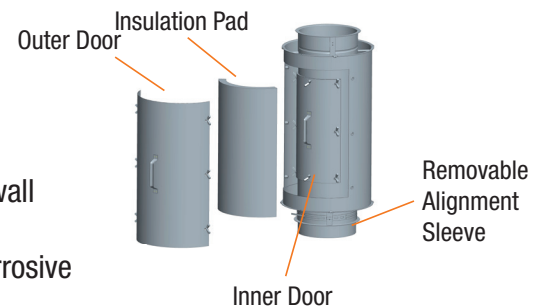

Warranty

- DuraVent: Limited Lifetime Warranty, includes all components and fittings.
- Competition: 12 months from date-of-shipment.